

OLYMPUS[®]

Your Vision, Our Future

System Microscope

BX53/BX43/BX46

BX3 Series

The New Standard in Ergonomics and Productivity

NEW



Your Choice for Clinical Applications

Olympus' BX3 series combines ergonomics with leading-edge optical technology in three models— the BX53, BX43, and BX46 microscopes. BX3 series microscopes have an ergonomic design that helps keep users comfortable during extended periods of use and an intuitive control layout for fast, efficient observation and imaging. Designed for laboratory and clinical applications, white LED illumination has a high luminosity and color-rendering index so users can see their samples in true-to-life colors.



BX46
Clinical Microscope



BX43
System Microscope



BX53
System Microscope

Comfortable and Efficient

Maintain a Natural Posture

Excellent Ergonomic Tube

Our most ergonomic option moves up and down, tilts, and extends forward and back so you can move it closer to you. With this one component, users of nearly any height can adjust the scope so that they're comfortable. The super ergonomic tube is suitable for labs where multiple users share a microscope since each can adjust it to accommodate their height and posture.



Tilts: 0 to 27 degrees



Extends: 55 mm



Lifts: 45 mm



Tilting Trinocular Tube

The tilting trinocular tube is designed for users who want the flexibility of an ergonomic component but need to attach a camera to their microscope. The optical path switch can be attached to either side of the tube, so both left and right handed users can comfortably switch from the camera to the eyepieces.



Tilting Binocular Tubes that Meet Your Needs

Our diverse lineup of tilting observation tubes provides flexibility in a variety of applications. From cost-effective models to tubes for erect image observation and eyepoint adjusters that accommodate user height differences, choose the tilting binocular tube that suits your needs.



Comfortable, Easy-to-Use Stage

Rackless Stage with Enhanced Operability

The stage has a rackless, wire-driven design with no teeth in the gear, helping to minimize injuries to users.

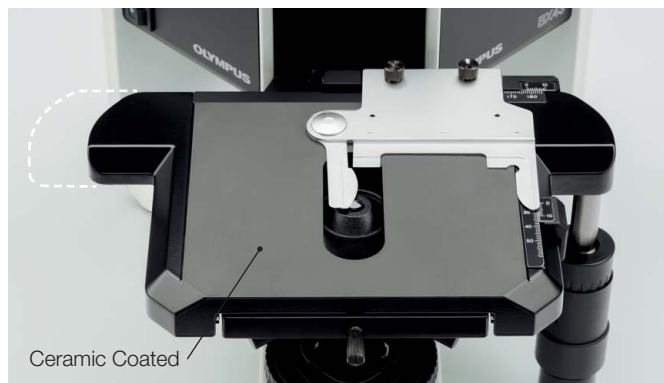

Abrasion Resistant and Durable Stage

Mechanical stages are coated with a durable ceramic, maximizing abrasion resistance and helping to keep the surface smooth.

Keep Your Hands on the Desk

The stage handle extender enables users to do their work while keeping their arms resting on the desk, resulting in less fatigue during extended use. Users can also mount a rubber cap to the handle so the stage can be controlled using light torque.



Before

After

Clear Observation with Reduced Eye Strain

Bright LED Lighting Designed for Pathology and Cytology

Designed with spectral characteristics that mimic halogen light sources, the BX3 series' LED illumination enables users to clearly view the purple, cyan, and pink colors important in pathology, but typically difficult to see using LEDs. Users get the benefits of an LED, including consistent color temperatures and long use life, without the typical trade offs.

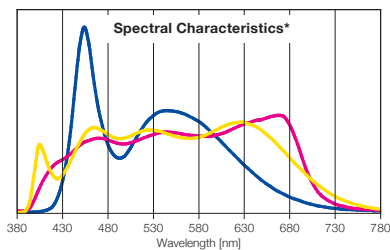
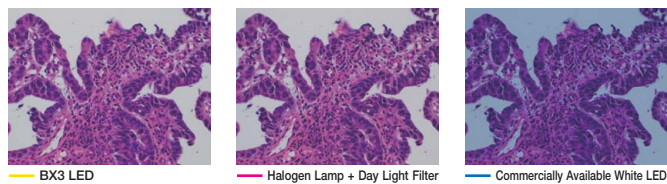

* This graph shows the spectral characteristics of each light source regularized with the luminosity curve. It does not compare the strength of light for each light source.

Maintain Brightness when Changing Magnifications

The BX3 series' light intensity manager eliminates the step of adjusting lamp brightness when changing magnification. By maintaining uniform brightness at any magnification, users can achieve their observations quickly and with reduced eye strain.

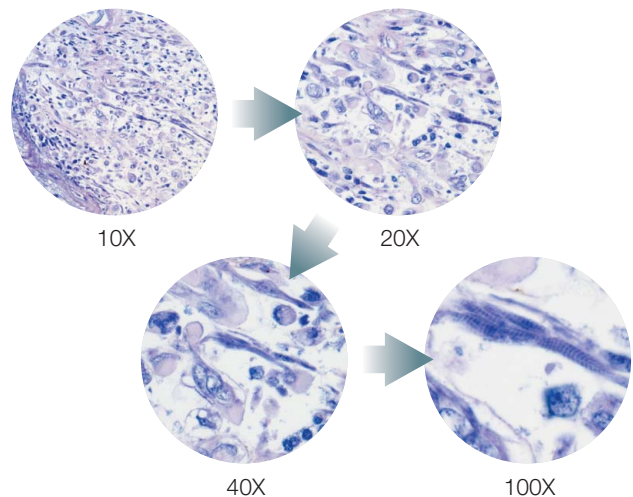

Efficient Image Capture

Easily Acquire High-Quality Images

Combining the BX3 series with cellSens imaging software makes acquiring high-quality images for documentation quick and easy. The "Simple Layout" improves efficiency and work flows for all users from novice to expert. All image acquisition functions are easily accessible for intuitive operation. This enables even untrained users to obtain excellent results.

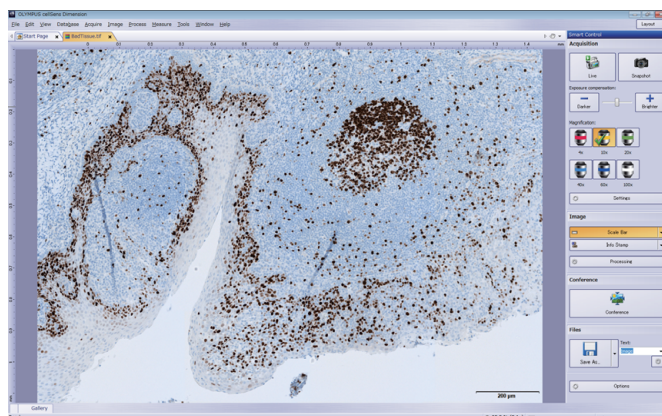

Capture Digital Images without Using a PC

The DP22 digital microscope camera makes it easy to observe, measure, and acquire images without using a PC. Focusing and specimen transfer are simplified thanks to precise color reproduction and smooth live images. With the DP22 camera, you can directly display specimens on a monitor and capture images for reports and conferences.



BX53+Digital Camera DP22 (Stand-alone) Configuration

Designed for Teaching and Challenging Applications

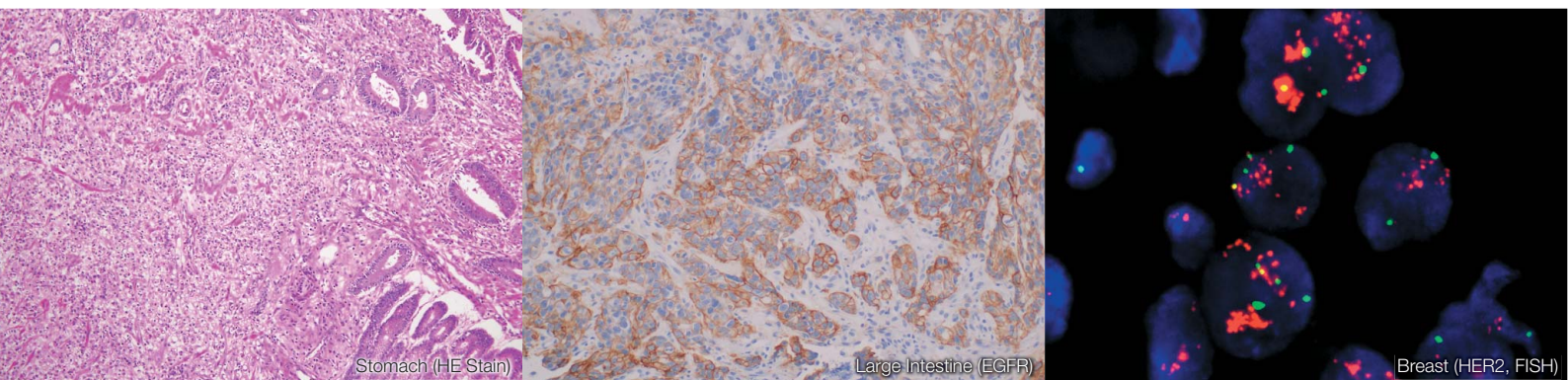

BX53

With an LED illuminator equivalent to or better than a 100 W halogen lamp, the BX53 microscope delivers outstanding brightness that's ideal for teaching and polarized light applications.

White LED with High Color Rendering—Equivalent to or better than a 100 W Halogen Lamp

Enjoy the benefits of LED illumination, such as a 50,000 hour use life, without compromising your ability to clearly see purple, cyan, and pink dyes. The BX53 microscope utilizes a white LED with a luminosity equivalent to or better than a 100 W halogen lamp. Since LEDs have a consistent color temperature, users won't have to waste time adjusting a color filter.



Bright Images in Multi-Head Configurations

Multi-head discussion systems are essential for training and education. With the BX53 microscope's LED illumination, up to 26 participants can view clear, bright images.



Quick Magnification Change with Motorized Functionality

Easily change objectives with a motorized nosepiece using a hand switch. The hand switch is located near the focus handle, enabling users to control the nosepiece without taking their eyes off the specimen.



Advanced Optical Performance Accommodates Various Observation Styles

Customize your BX53 microscope with modular units that enable different observations. Choose from options including condensers, nosepieces, a rotating stage, objectives, and intermediate optics optimized for various observation methods, including polarization, phase contrast, and fluorescence.

Even Fluorescence Illumination Across the Field of View

Eight fluorescence mirror units can be attached to the microscope's illuminators for multi-color fluorescence observations. The integrated fly-eye lenses provide even illumination. High-performance filters improve the efficiency of your fluorescence observation, especially when detecting tuberculosis bacterium and the HER2 receptor protein in mammary tissue. To improve the signal-to-noise ratio, use our collector lens shutter to prevent autofluorescence of the transmitted light path.

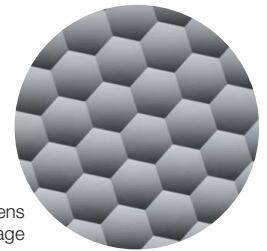

Surface of fly-eye-lens system, Enlarged Image



Excellent Performance in a Cost-Effective System

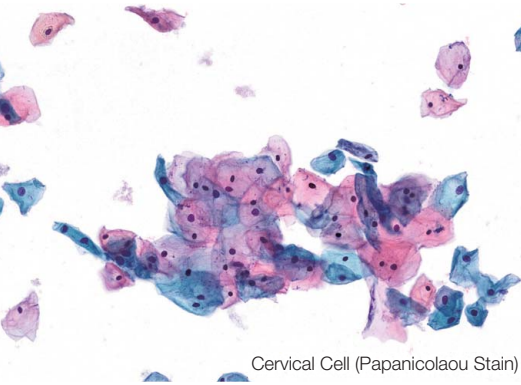

Cervical Cell (Papanicolaou Stain)

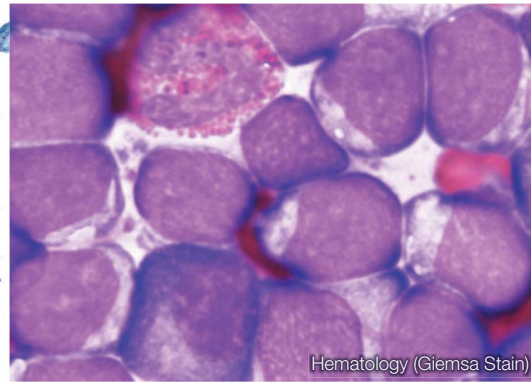

Hematology (Giemsa Stain)

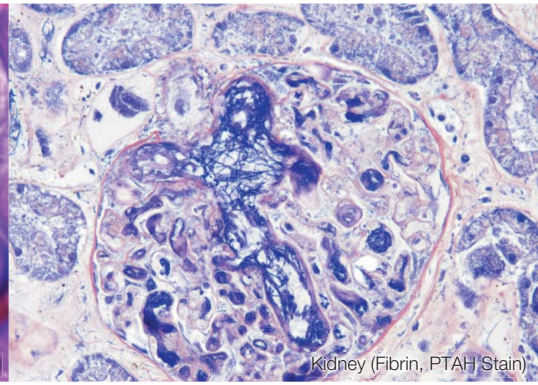

Kidney (Fibrin, PTAH Stain)



BX43

Take advantage of the BX3 series' advanced features in a cost-effective model. Durable and easy to use, the BX43 microscope maximizes efficiency in busy testing labs. It's easy to expand the microscope's capabilities so users can add functionality as their needs change.

White LED with High Color Rendering— Equivalent to a 30 W Halogen Lamp

The BX43 microscope utilizes a high color rendering white LED with a luminosity equivalent to a 30 W halogen lamp. The long-lasting LED provides users a consistent color temperature at any brightness level.



Low Magnification Condenser

With an optional low magnification condenser, users can change the objective magnification from 2X to 100X (dry) without changing the condenser or moving the top lens.

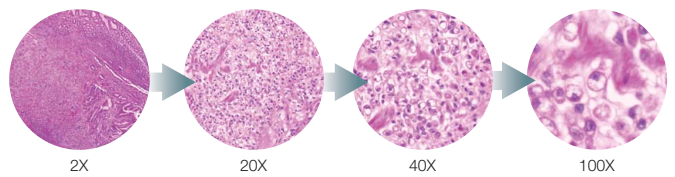

Bright Images in Dual-Headed Discussion Setup

In face-to-face or side-by-side configuration, the microscope's LED illuminator delivers bright images to the second user to facilitate discussion.

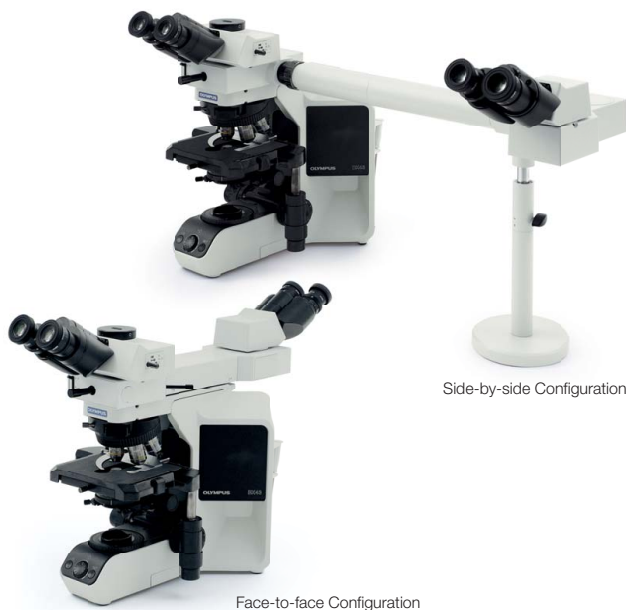

Fully Customizable

Choose from a wide variety of modular components, including ergonomic observation tubes and stages, to customize the microscope to your specific application.



Designed for Routine Pathology and Cytology

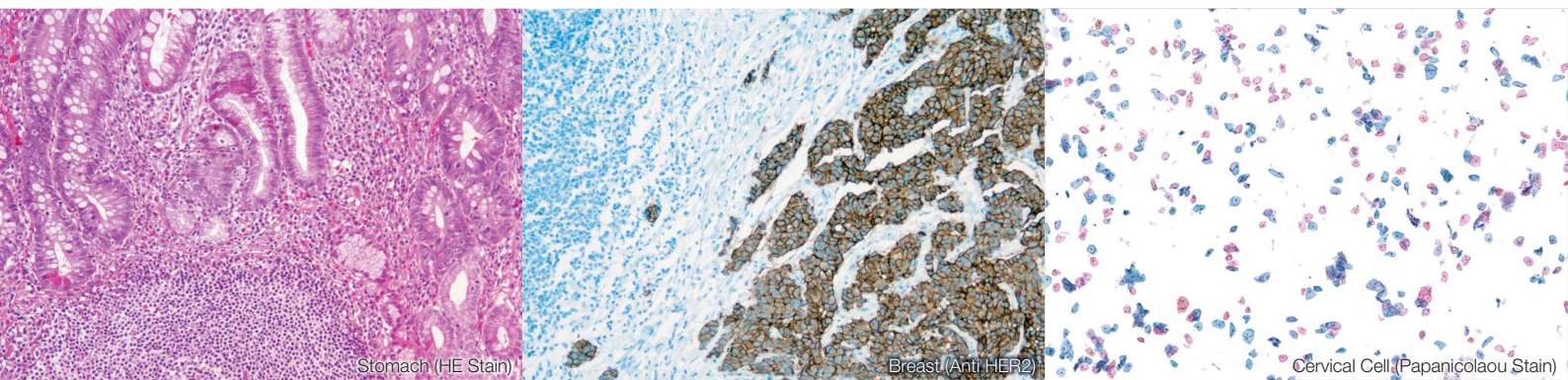

BX46

With an ergonomic design and advanced features, the BX46 microscope helps keep users comfortable during routine pathology and cytology.

Be Comfortable While You Work

The microscope's super ergonomic binocular tube tilts, slides forward and backward, and moves up and down so users of almost any height can remain comfortable while they work.



Revolving Nosepiece with Light Intensity Manager

The microscope's five position, coded nosepiece works with the light intensity manager to automatically adjust the brightness based on the objective being used. The result is uniform brightness from low to high magnification, eliminating intensity adjustments and reducing eye fatigue.

Swap Out Specimen Slides Quickly

The BX46 microscope has a low-position and inward tilted nosepiece. Coupled with the low-position fixed stage, it's easy to swap out slides quickly with minimal hand movement.

Fast Magnification Change

The low-position and inward tilted design of the nosepiece enables operators to quickly change magnification with minimal arm movement, improving scanning efficiency.



Easy, Ergonomic Manual Stage Movement

A simple finger tap is all that is needed to move the specimen. The low-position handles and low torque stage make it easy to move the specimen while users keep their arms and hands in a comfortable position.



Group Observation Systems

Multi-head discussion systems are invaluable for lab training and education. Olympus offers discussion systems for as few as two or as many as 26 people. With our BX3 series multi-discussion observation (MDO) system, every participant can see the same high-quality image. The integrated LED arrow pointer helps instructors highlight key features in the teaching specimen.



Designed to Meet Your Needs

Olympus' UIS2 infinity-corrected optical system facilitates future scalability. Inserting an optical element into the infinity space causes no additional image distortion or deterioration in image quality.



UPLSAPO Series

Thanks to our original US multi-coatings, our Super Apochromat objectives compensate for spherical and chromatic aberrations from the UV to the near infrared region. The objectives' sensitivity to fluorescence emissions enables the acquisition of sharp, clear images without color shift, even in brightfield observation. For quality and performance, these objectives are great for digital imaging.



UPLFLN (UPLFLN-PH) Series

These plan objectives provide flat images with high transmission up to the near infrared region of the spectrum. With their high signal-to-noise ratio, excellent resolution, and high contrast images, the objectives are especially effective in brightfield observation. The UPLFLN-PH series is optimized for phase contrast observation.



PLAPON Series

Designed for excellent resolution and contrast, Plan Apochromat objectives reduce chromatic aberration to low levels. Both 1.25X and 2X objectives are available.



PLN (PLN-PH) Series

Appropriate for a range of clinical and research applications, these high-quality objectives offer excellent flatness up to FN 22 in transmitted brightfield (phase contrast) observation. The PLN-PH series is designed for phase contrast observation.



No Cover Objectives

Olympus' coverglass-free objectives are designed to be used with glass slides that do not have a cover slip, such as when observing blood smear specimens.



Versatile Observation Methods

Brightfield

Get Bright Images with Excellent Resolution/Flatness at All Magnifications

Olympus' diverse line of condensers enable users to choose what they need for their application. For example, the U-SC3 swing-out condenser is suitable for observations from 1.25X to 100X, the U-LC is optimized for consecutive observations from 2X to 100X (dry), the U-AAC reduces aberration, and the U-ULC-2 is specially-designed for ultra-low magnifications.

*Select the U-ULC2 condenser for optimal digital imaging with the 1.25X objective.

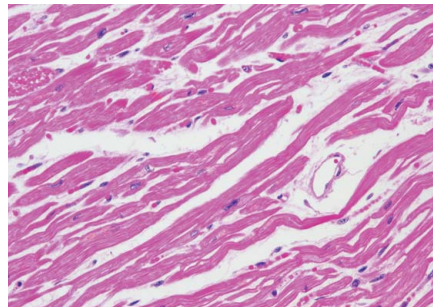

Hert (HE)

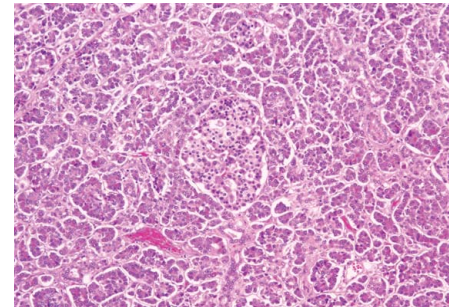

Hert (HE)

Suitable for Cellular Tissue Observation / LPLN40X

This objective is ideal for imaging thick, clear samples, even at 40X magnification. The LPLN40X is equipped with a correction collar so users can adjust the spherical aberration caused by differences in cover glass thickness to get clear images.

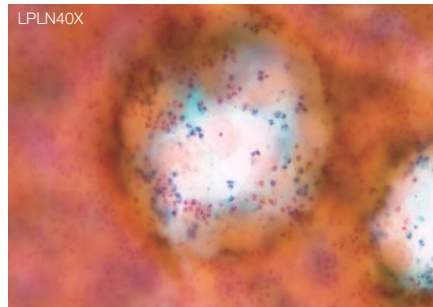

Uterine corpus (PAP)

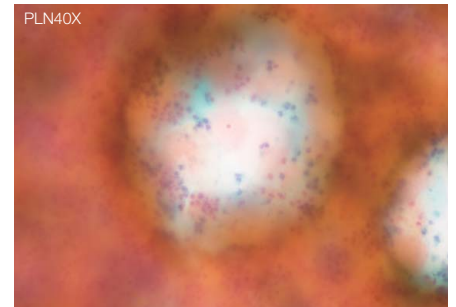

Uterine corpus (PAP)

Polarized Light

High-resolution View of Double Refraction Structure in Cells

Tooth, bone, muscle tissue, nerve tissue, actomyosin fiber, and mitotic spindle can all be observed without staining. There are intermediate attachments (U-OPA/U-CPA) for orthoscopic and orthoscopic/conoscopic viewing. Various compensators make it possible to observe a wide range of retardation. Also available are a condenser exclusively for polarized light observation, revolving nosepiece, rotating stage, objectives, simple polarizing attachment, and analyzer to detect uric acid crystal.

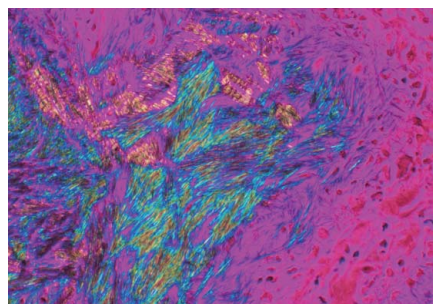

Uric acid crystal

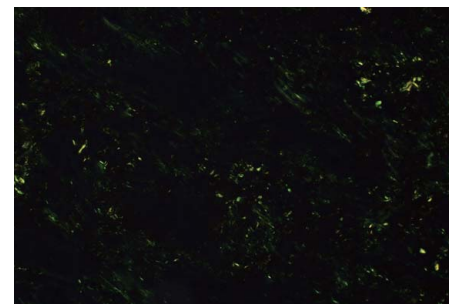

Amyloid

Fluorescence

Get More Options with Olympus' Standard 8-Position Filter Turret

Users can choose from a universal reflected illuminator or a coded fluorescence illuminator. Eight fluorescence mirror units can be attached to the microscope for efficient multi-color fluorescence observations. High-performance filters provide efficient and bright fluorescence images.

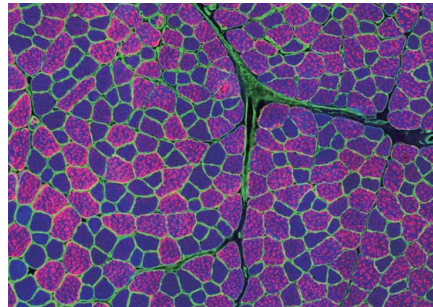

Muscle Tissue (fluorescence)

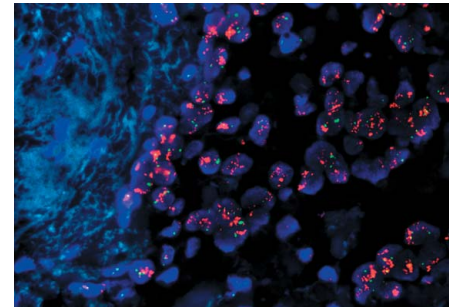

Mammary gland tissue (fluorescence)

Phase Contrast

High-Contrast, High-Resolution Imaging

High-contrast phase imaging enables close observation of the interior of a cell and live bacteria. Use the UPLFLN-PH or PLN-PH objectives for phase contrast observation from 10X to 100X. With the U-PCD2 phase/darkfield condenser, users can view specimens in brightfield or darkfield. Simultaneous observation with reflected light fluorescence microscopy is also possible.

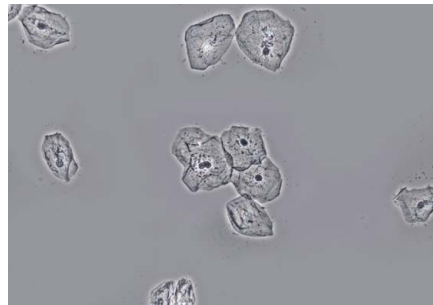

Endothelial Cells

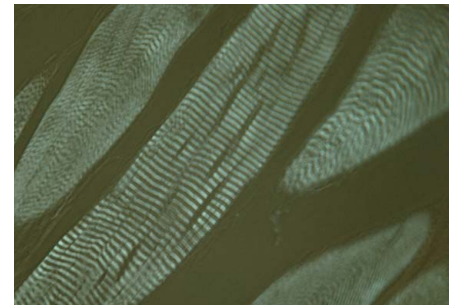

Musculus

Darkfield

Excellent Darkfield Effect from Low to High Magnifications

Choose from a 10X to 100X dry darkfield condenser or a 20X to 100X oil immersion darkfield condenser.

*Please consult your nearest Olympus representative for applicable objectives.

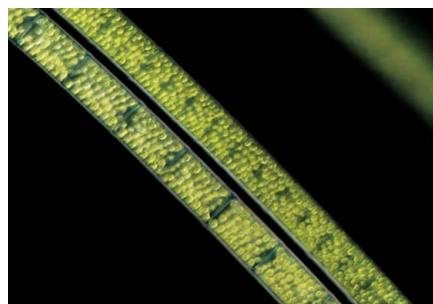

Spirogyra

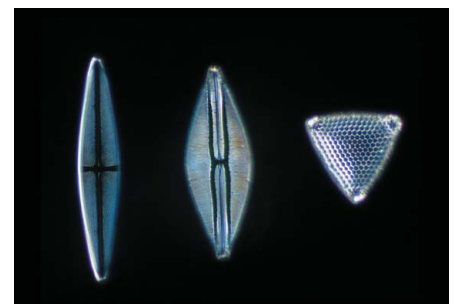

Diatom

BX53 SYSTEM DIAGRAM

◆ **WHN10X-H, CROSS WHN10X**
Eyepieces
U-CT30-2
Centering telescope

* **WHN10X, WHN10X-H, CROSS WHN10X**
Eyepieces
U-CT30-2
Centering telescope

▲ **SWH10X-H, CROSS SWH10X, MICRO SWH10X**
Eyepieces
U-CT30-2
Centering telescope

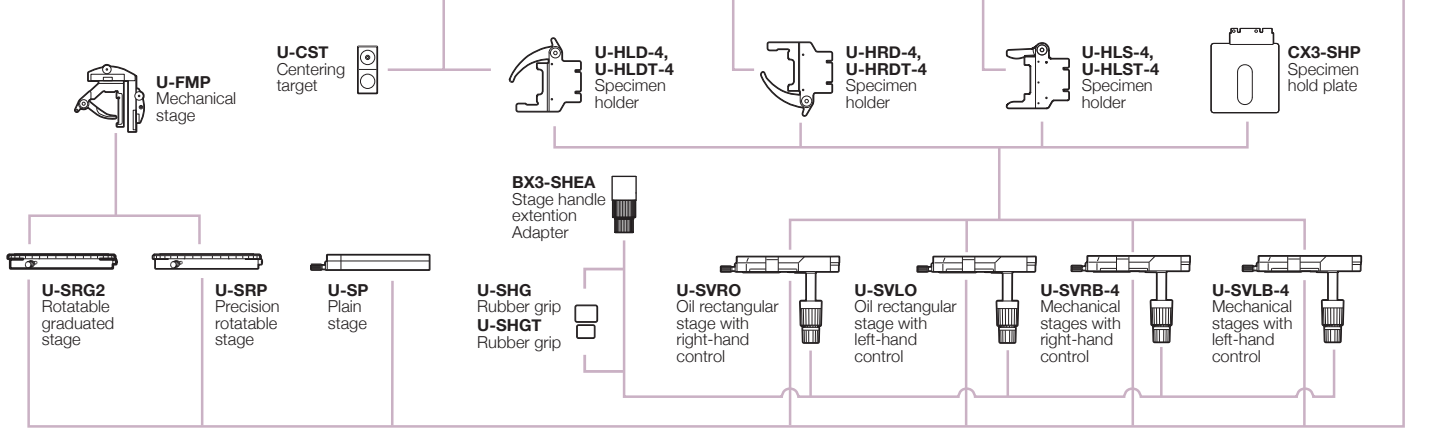
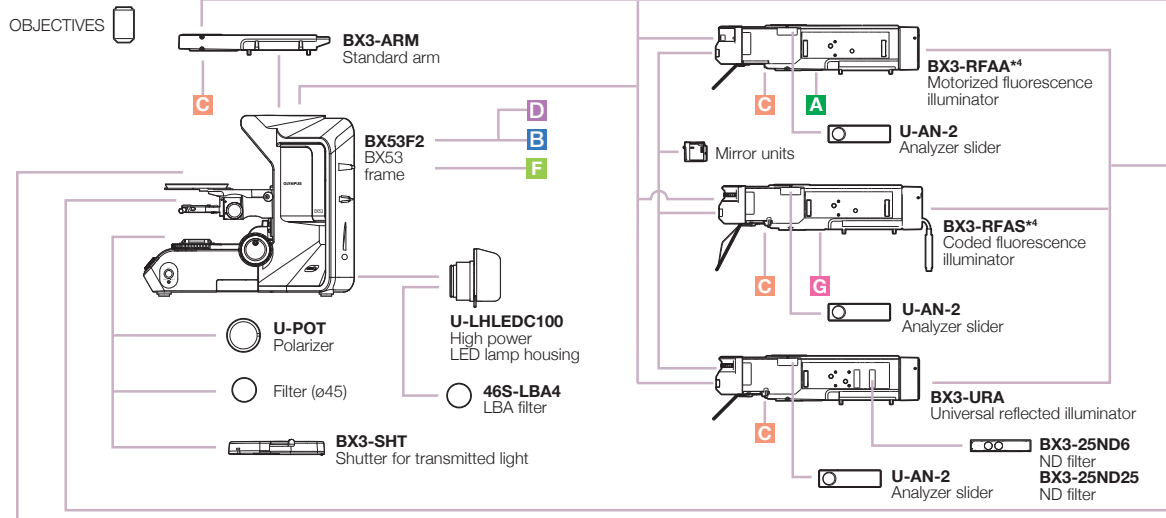
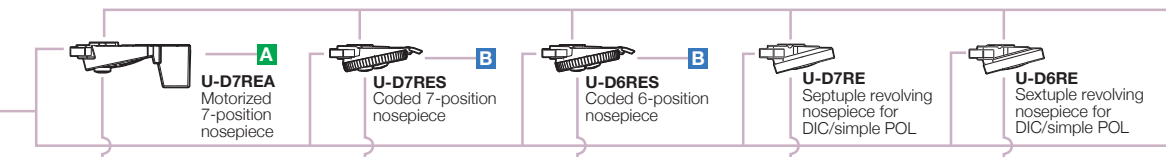
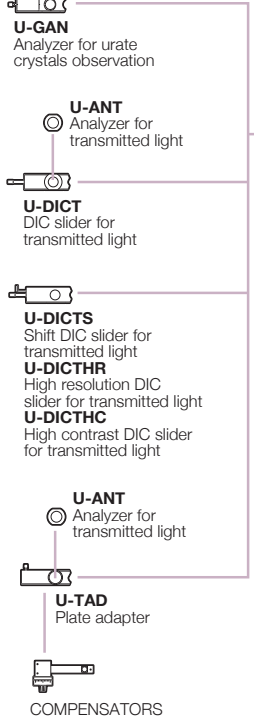
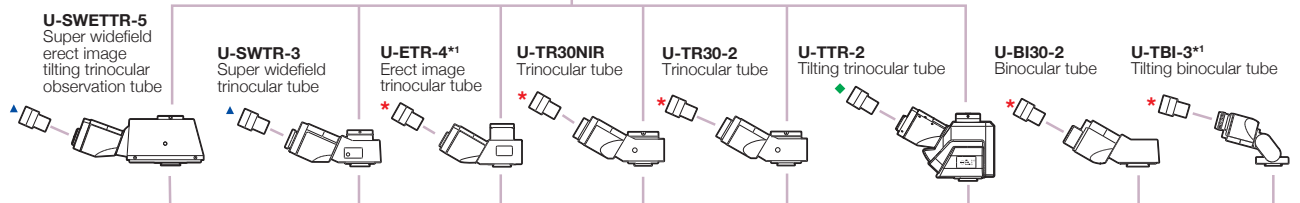
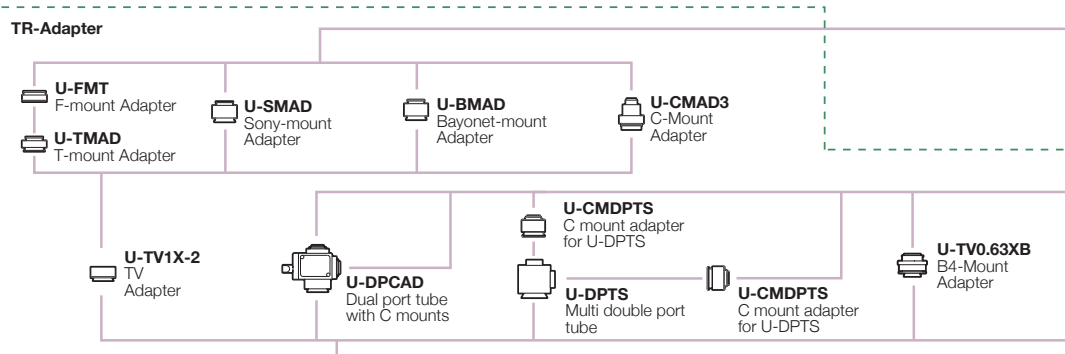

*1 Slight vignetting may occur in combination with an additional intermediate attachment or observation method. *2 Require an additional intermediate attachment or fluorescence illuminator. *3 Cannot be used with U-TTLBI. *4 Compatible with FN 22. *5 Cannot be used with BX3-URA. *6 Stand is a standard equipment of the U-MDOSV, BX3-MDO18R, and U-MDO10R3.

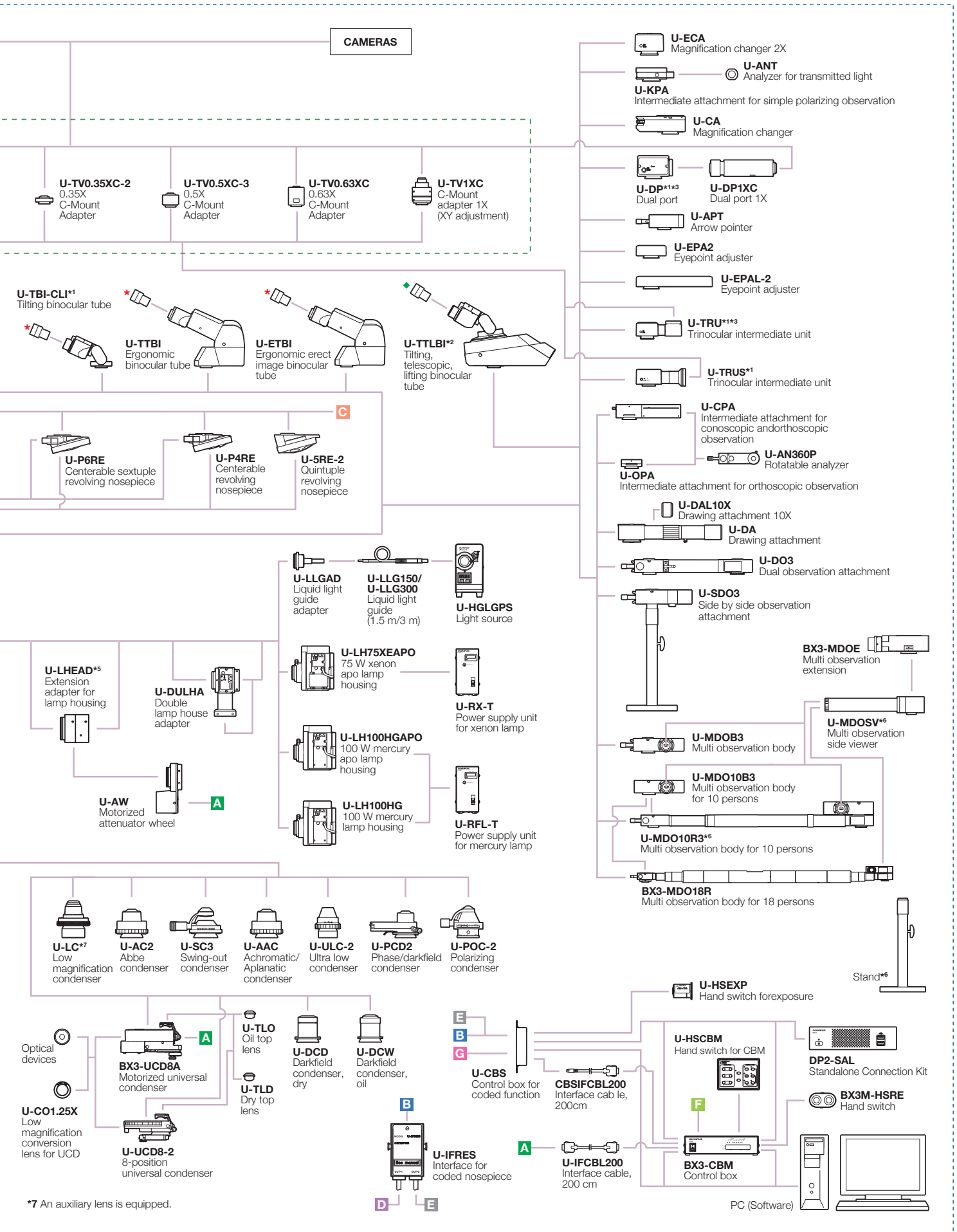

BX43 SYSTEM DIAGRAM

◆ WHN10X-H,
CROSS WHN10X
Eyepieces
U-CT30-2
Centering telescope

* WHN10X, WHN10X-H,
CROSS WHN10X
Eyepieces
U-CT30-2
Centering telescope

▲ SWH10X-H,
CROSS SWH10X,
MICRO SWH10X
Eyepieces
U-CT30-2
Centering telescope

TR-Adapter

U-FMT
F-mount
Adapter
U-TMAD
T-mount
Adapter

U-SMAD
Sony-mount
Adapter

U-BMAD
Bayonet-mount
Adapter

U-CMAD3
C-Mount
Adapter

U-TV1X-2
TV
Adapter

U-DPCAD
Dual port tube
with C-mounts

U-CMDPTS
C mount adapter
for U-DPTS

U-DPTS
Multi double
port tube

U-CMDPTS
C mount adapter
for U-DPTS

U-TV0.63XB
B4-Mount
Adapter

U-SWETTR-5
Super widefield
erect image
tilting trinocular
observation tube

U-SWTR-3
Super widefield
trinocular tube

U-ETR-4*¹
Erect image
trinocular tube

U-TR30NIR
Trinocular tube

U-TR30-2
Trinocular tube

U-TTR-2
Tilting trinocular
tube

U-BI30-2
Binocular tube

U-TBI-3*¹
Tilting binocular
tube

U-GAN
Analyzer for urate
crystals observation

U-ANT
Analyzer for
transmitted light

U-DICT
DIC slider for
transmitted light

U-DICTS
Shift DIC slider for
transmitted light
U-DICTHR
High resolution DIC
slider for transmitted light
U-DICTHC
High contrast DIC slider
for transmitted light

U-ANT
Analyzer for
transmitted light

U-TAD
Plate adapter

COMPENSATORS

U-FMP
Mechanical
stage

U-SRG2
Rotatable
graduated
stage

U-SRP
Precision
rotatable
stage

U-SP
Plain
stage

U-SHG
Rubber grip
U-SHGT
Rubber grip

U-SVRO
Oil rectangular
stage with
right-hand
control

U-SVLO
Oil rectangular
stage with
left-hand
control

U-SVRB-4
Mechanical
stages with
right-hand
control

U-SVLB-4
Mechanical
stages with
left-hand
control

OBJECTIVES

U-D7RES
Coded
7-position
nosepiece

U-D6RES
Coded
6-position
nosepiece

U-D7RE
Septuple revolving
nosepiece for
DIC/simple POL

U-D6RE
Sextuple revolving
nosepiece for
DIC/simple POL

U-P6RE
Centerable
revolving
nosepiece

U-P4RE
Centerable
revolving
nosepiece

BX43F
BX43 frame

U-LHLEDC
LED lamp housing

U-POT
Polarizer

BX3-SHT
Shutter for transmitted light

U-CST
Centering target

U-HLD-4,
U-HLDT-4
Specimen
holder

U-HRD-4,
U-HRDT-4
Specimen
holder

U-HLS-4,
U-HLST-4
Specimen
holder

CX3-SHP
Specimen
hold plate

BX3-SHEA
Stage handle
extension
Adapter

*1 Slight vignetting may occur in combination with an additional intermediate attachment or observation method.

*2 Require an additional intermediate attachment or fluorescence illuminator. *3 Cannot be used with U-TTLBI. *4 Compatible with FN 22. *5 An auxiliary lens is equipped.

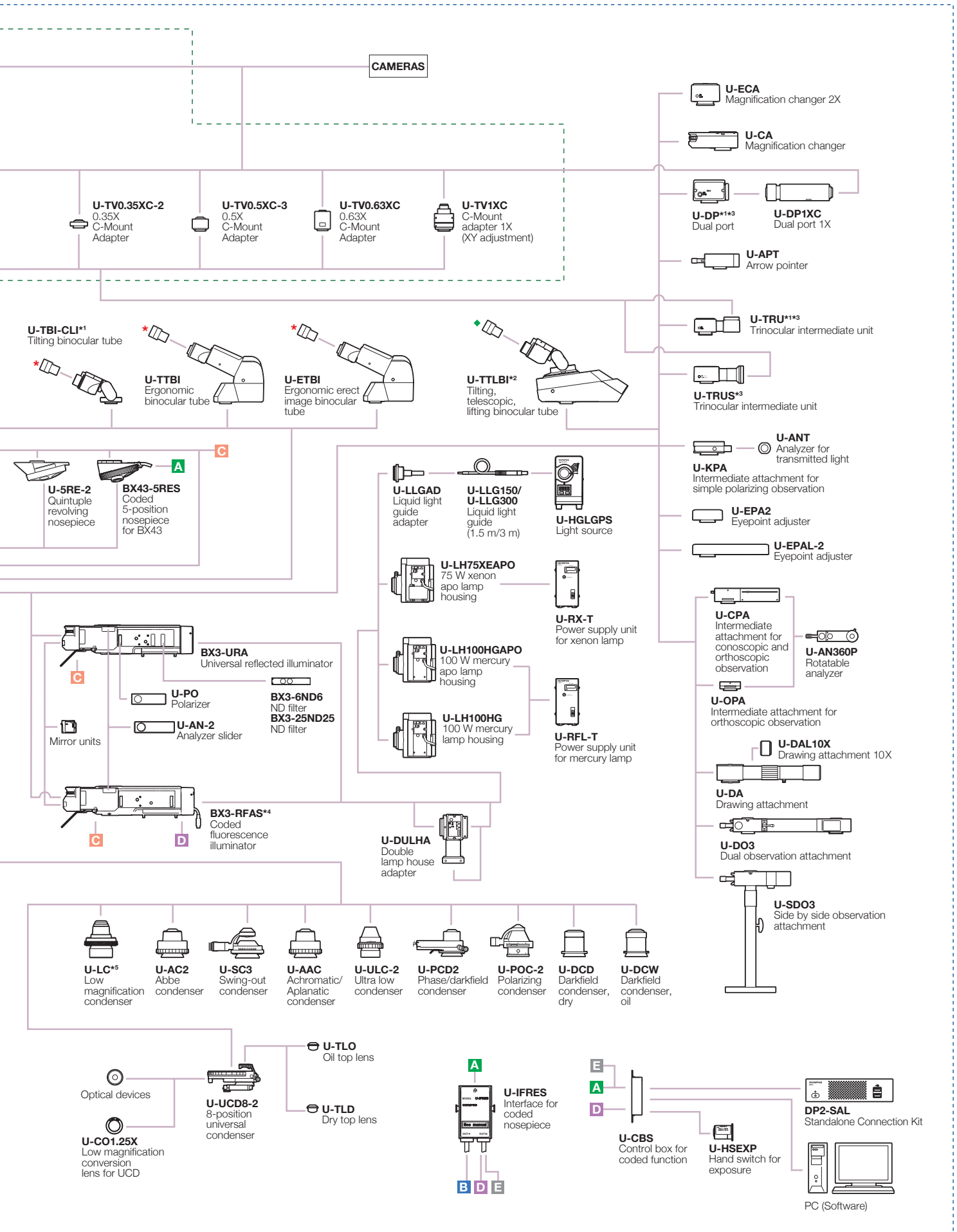

BX46 SYSTEM DIAGRAM

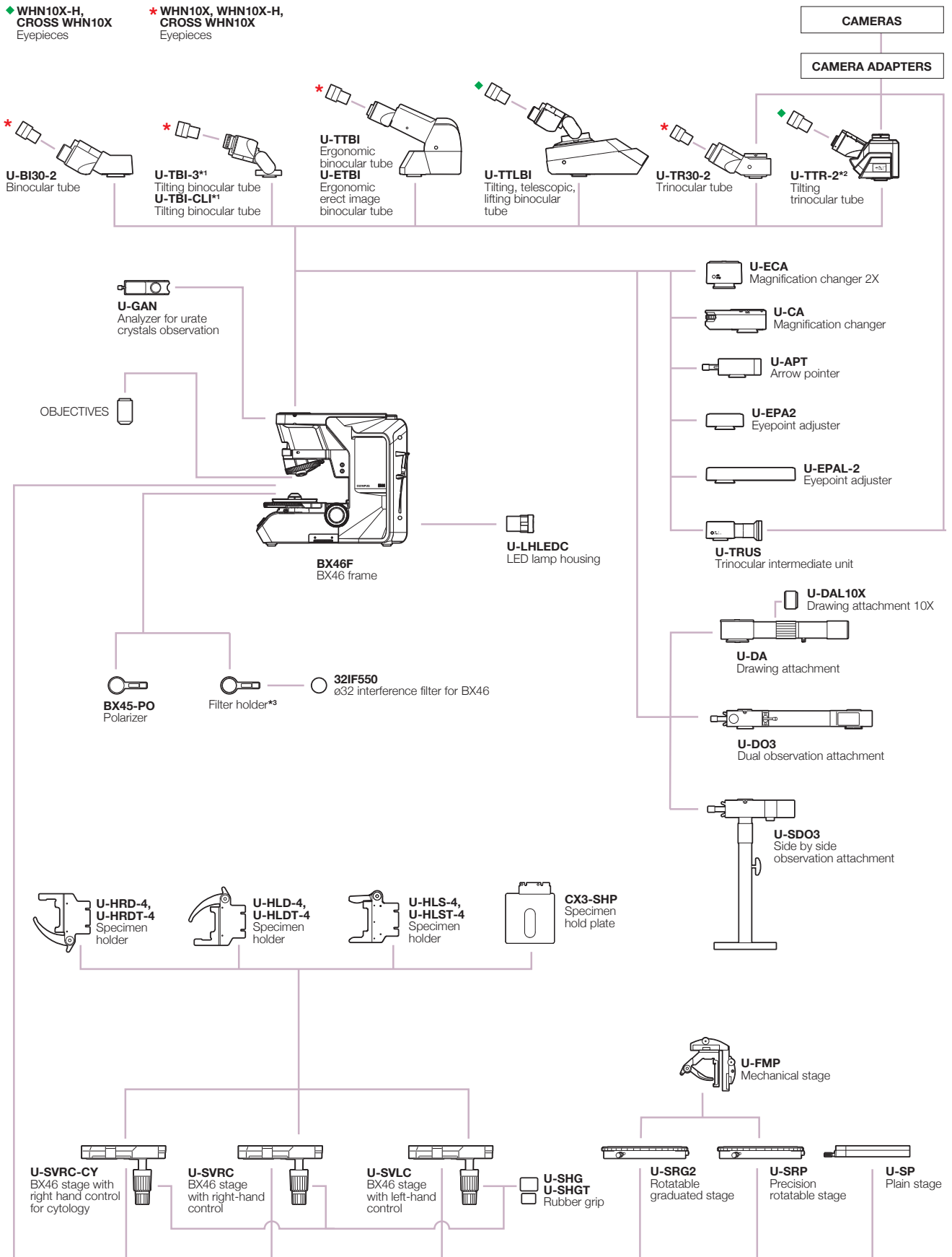

*1 Vignetting may occur in combination with an additional intermediate attachment.
*3 Attached to BX46F.

*2 Only U-EPA-2 and U-EPAL-2 are able to use as an additional intermediate attachment.

BX53 SPECIFICATIONS

Microscope Frame	Optical System	UIS2 optical system
	Focus	Vertical stage movement: 25 mm stage stroke with coarse adjustment limit stopper, torque adjustment for coarse adjustment knobs, stage mounting position variable, high sensitivity fine focusing knob (minimum adjustment gradations: 1 µm)
	Illuminator	Built-in Koehler illumination for transmitted light, light preset switch, light intensity manager switch, high color reproductivity 14 W LED light source
Revolving Nosepiece	Interchangeable reversed quintuple/coded quintuple/sextuple/septuple/coded sextuple/coded septuple nosepiece	
Observation Tube	Widefield (FN 22)	<ul style="list-style-type: none"> • Widefield tilting trinocular • Widefield trinocular • Widefield tilting binocular • Widefield tilting, telescoping and lifting binocular • Widefield ergo binocular • Widefield binocular
	Super Widefield (FN 26.5)	<ul style="list-style-type: none"> • Super widefield trinocular • Super widefield erect image tilting trinocular
Stage	Ceramic-coated coaxial stage with left or right hand low drive control: with rotating mechanism and torque adjustment mechanism, optional rubber grips and stage handle extension adapter available (non stick grooved coaxial, plain, rotatable stages are also available)	
Condenser	<ul style="list-style-type: none"> • Abbe (NA 1.1), for 4X–100X • Swing out Achromatic (NA 0.9), for 1.25X–100X (swing-out: 1.25X–4X) • Achromatic Aplanatic (NA 1.4), for 10X–100X • Phase contrast, darkfield (NA 1.1), [phase contrast: for 10X–100X, darkfield: for 10X–100X (up to NA 0.80)] • Universal (NA 0.9), for 1.25X–100X [swing-out: 1.25X–4X, with oil top lens:(NA 1.4)] • Low (NA 0.75), for 2X–100X (Dry) • Ultra low (NA 0.16), for 1.25X–4X • Darkfield dry (NA 0.8–0.92), for 10X–100X • Darkfield oil (NA 1.20–1.40), for 10X–100X 	
Fluorescence Illuminator	<ul style="list-style-type: none"> • Multi-purpose coded type (FN 22, 8-position mirror unit turret, 4-position ND slider) • Economical type (FN 26.5, 8-position mirror unit turret) 	
Fluorescence Light Source	100 W Hg apo lamp housing and transformer, 100 W Hg lamp housing and transformer, 75 W Xe lamp housing and transformer or 130 W Hg light guide illumination	

BX43 SPECIFICATIONS

Microscope Frame	Optical System	UIS2 optical system
	Focus	Vertical stage movement: 25 mm stage stroke with coarse adjustment limit stopper, torque adjustment for coarse adjustment knobs, stage mounting position variable, high sensitivity fine focusing knob (minimum adjustment gradations: 1 µm)
	Illuminator	Built-in Koehler illumination for transmitted light, light intensity manager switch high color reproductivity 2 W LED light source
Revolving Nosepiece	Interchangeable reversed quintuple/coded quintuple/sextuple/septuple/coded sextuple/coded septuple nosepiece	
Observation Tube	Widefield (FN 22)	<ul style="list-style-type: none"> • Widefield tilting, telescopic and lifting binocular • Widefield tilting trinocular • Widefield trinocular • Widefield erect image trinocular • Widefield tilting binocular • Widefield ergo binocular • Widefield binocular
	Super Widefield (FN 26.5)	<ul style="list-style-type: none"> • Super widefield trinocular • Super widefield erect image tilting trinocular
Stage	Ceramic-coated coaxial stage with left or right hand low drive control: with rotating mechanism and torque adjustment mechanism, optional rubber grips and stage handle extension adapter available (non stick grooved coaxial, plain, rotatable stages are also available)	
Condenser	<ul style="list-style-type: none"> • Abbe (NA 1.1), for 4X–100X • Swing out Achromatic (NA 0.9), for 1.25X–100X (swing-out: 1.25X–4X) • Achromatic Aplanatic (NA 1.4), for 10X–100X • Phase contrast, darkfield (NA 1.1), [phase contrast: for 10X–100X, darkfield: for 10X–100X (up to NA 0.80)] • Universal (NA 0.9), for 1.25X–100X [swing-out: 1.25X–4X, with oil top lens:(NA 1.4)] • Low (NA 0.75), for 2X–100X (Dry) • Ultra low (NA 0.16), for 1.25X–4X • Darkfield dry (NA 0.8–0.92), for 10X–100X • Darkfield oil (NA 1.20–1.40), for 10X–100X 	

BX46 SPECIFICATIONS

Microscope Frame	Optical System	UIS2 optical system
	Focus	Fixed low stage nosepiece focus 15 mm focus stroke with coarse adjustment limit stop Torque adjustment for coarse adjustment knobs High sensitivity fine focusing knob (adjustment gradations: 1 µm)
	Illuminator	Built-in Koehler illumination for transmitted light, light intensity manager switch High color reproductivity 2 W LED light source
Revolving Nosepiece	Fixed reversed coded quintuple nosepiece	
Observation Tube	Widefield (FN 22)	<ul style="list-style-type: none"> • Widefield tilting trinocular • Widefield trinocular • Widefield tilting binocular • Widefield tilting, telescopic, lifting binocular • Widefield ergo binocular • Widefield binocular
Stage	Ceramic-coated coaxial stage with left or right hand low drive control, rotating mechanism and torque adjustment mechanism (low torque, plain, rotating stages are also available)	
Condenser	Built-in condenser (NA 0.9) 1.25X–100X (swing out: 1.25X–2X)	

BX53/BX43/BX46 SPECIFICATIONS

Operating Environment	<ul style="list-style-type: none"> • Indoor use • Ambient temperature : 5° to 40°C (41° to 104° F) • Maximum relative humidity : 80% for temperatures up to 31°C (88°F), decreasing linearly through 70% at 34°C (93°F), 60% at 37°C (99°F), to 50% relative humidity at 40°C (104°F) • Supply voltage fluctuations : not to exceed ±10 % of the normal voltage
-----------------------	---

BX53 DIMENSIONS

(unit: mm)

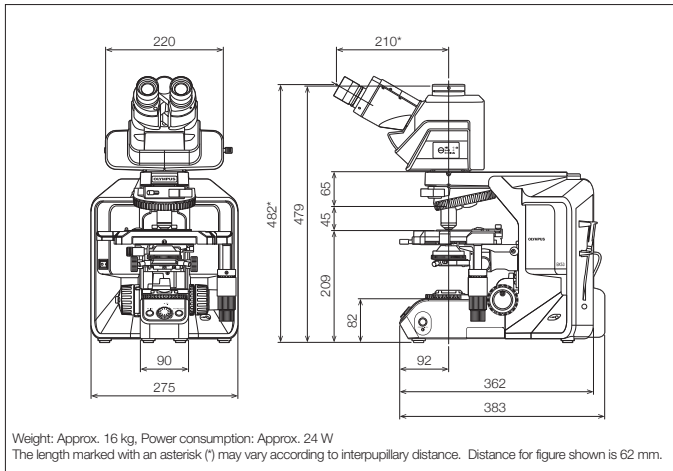
**BX53 FL DIMENSIONS**

(unit: mm)

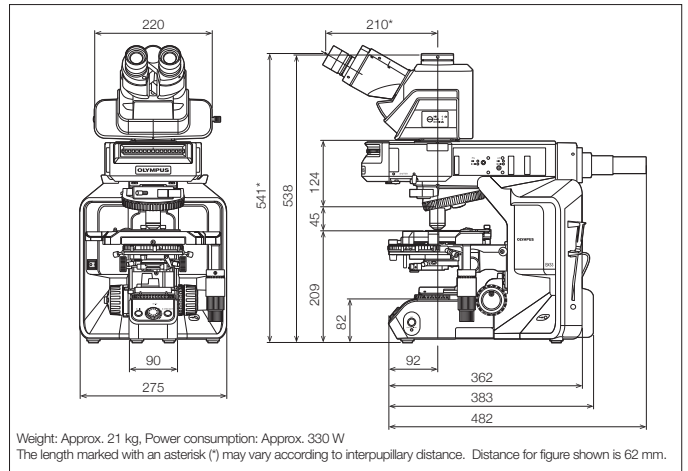
**BX43 DIMENSIONS**

(unit: mm)

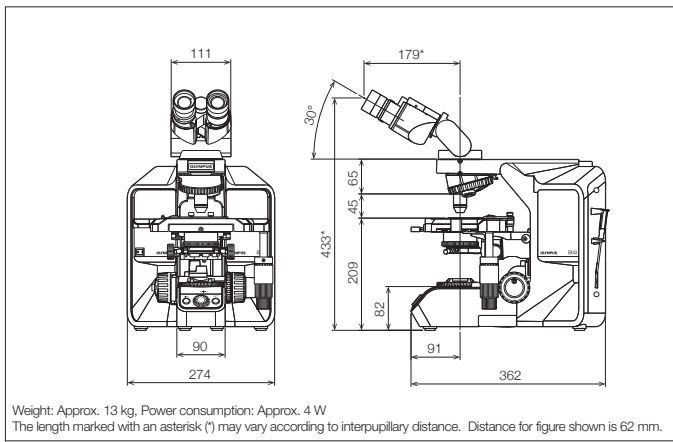
**BX46 DIMENSIONS**

(unit: mm)

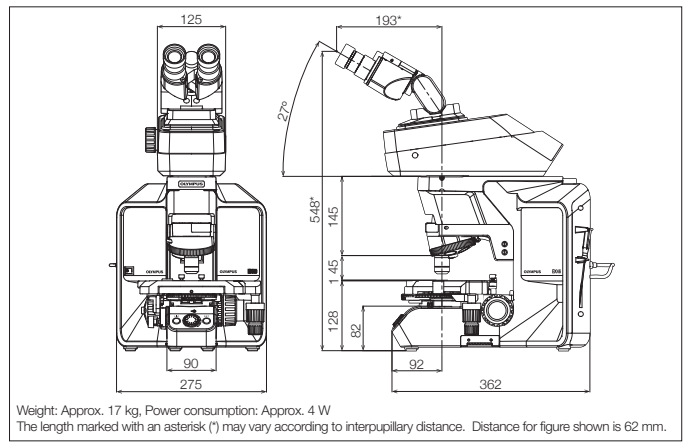

BX53+BX3-MDO18/MDO26 DIMENSIONS

(unit: mm)

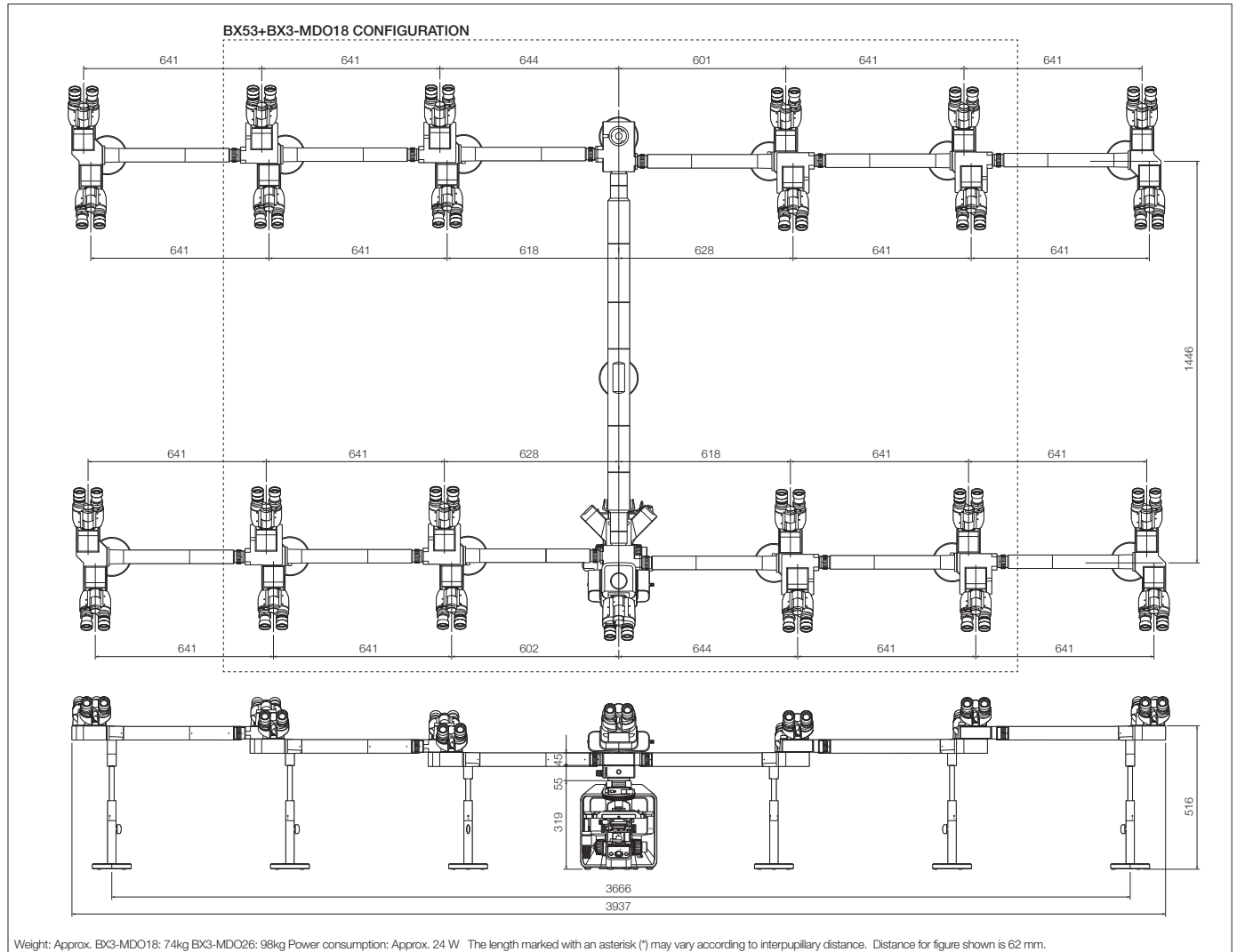

Weight: Approx. BX3-MDO18: 74kg BX3-MDO26: 98kg Power consumption: Approx. 24 W The length marked with an asterisk (*) may vary according to interpupillary distance. Distance for figure shown is 62 mm.

BX53+U-MDO10 DIMENSIONS

(unit: mm)

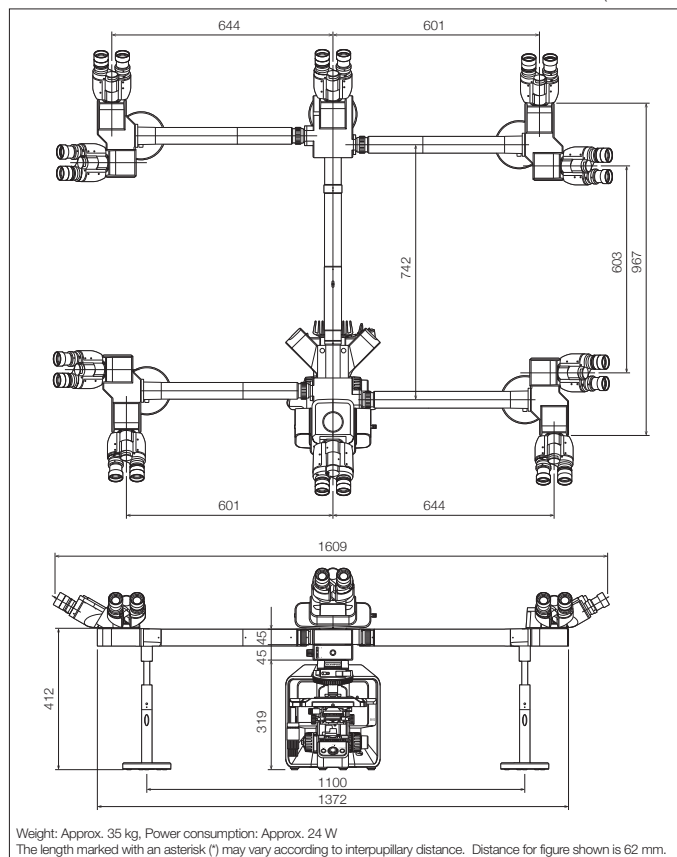

Weight: Approx. 35 kg, Power consumption: Approx. 24 W
The length marked with an asterisk (*) may vary according to interpupillary distance. Distance for figure shown is 62 mm.

BX53 + U-DO DIMENSIONS

(unit: mm)

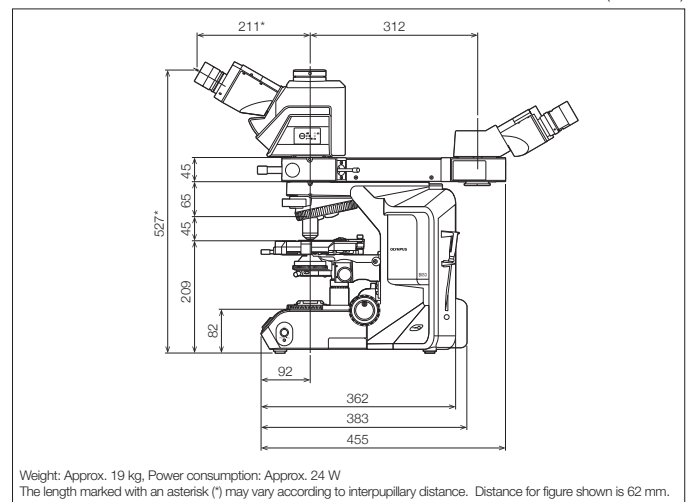

Weight: Approx. 19 kg, Power consumption: Approx. 24 W
The length marked with an asterisk (*) may vary according to interpupillary distance. Distance for figure shown is 62 mm.

- OLYMPUS CORPORATION is ISO14001 certified.
- OLYMPUS CORPORATION is ISO9001 certified.
- OLYMPUS CORPORATION is ISO13485 certified.
- Illumination devices for microscope have suggested lifetimes.
Periodic inspections are required. Please visit our website for details.

- All company and product names are registered trademarks and/or trademarks of their respective owners.
- Images on the PC monitors are simulated.
- Specifications and appearances are subject to change without any notice or obligation on the part of the manufacturer.

www.olympus-lifescience.com

OLYMPUS[®]

OLYMPUS CORPORATION
Shinjuku Monolith, 2-3-1 Nishi-Shinjuku, Shinjuku-ku, Tokyo 163-0914, Japan

Printed in Japan M1696E-062017