

OLYMPUS[®]

Your Vision, Our Future

Research Stereo Microscope System

SZX16/SZX10

For Industrial Use

Outstanding Optical Performance in an Ergonomic Design



A New Dimension of Industrial Microscopy

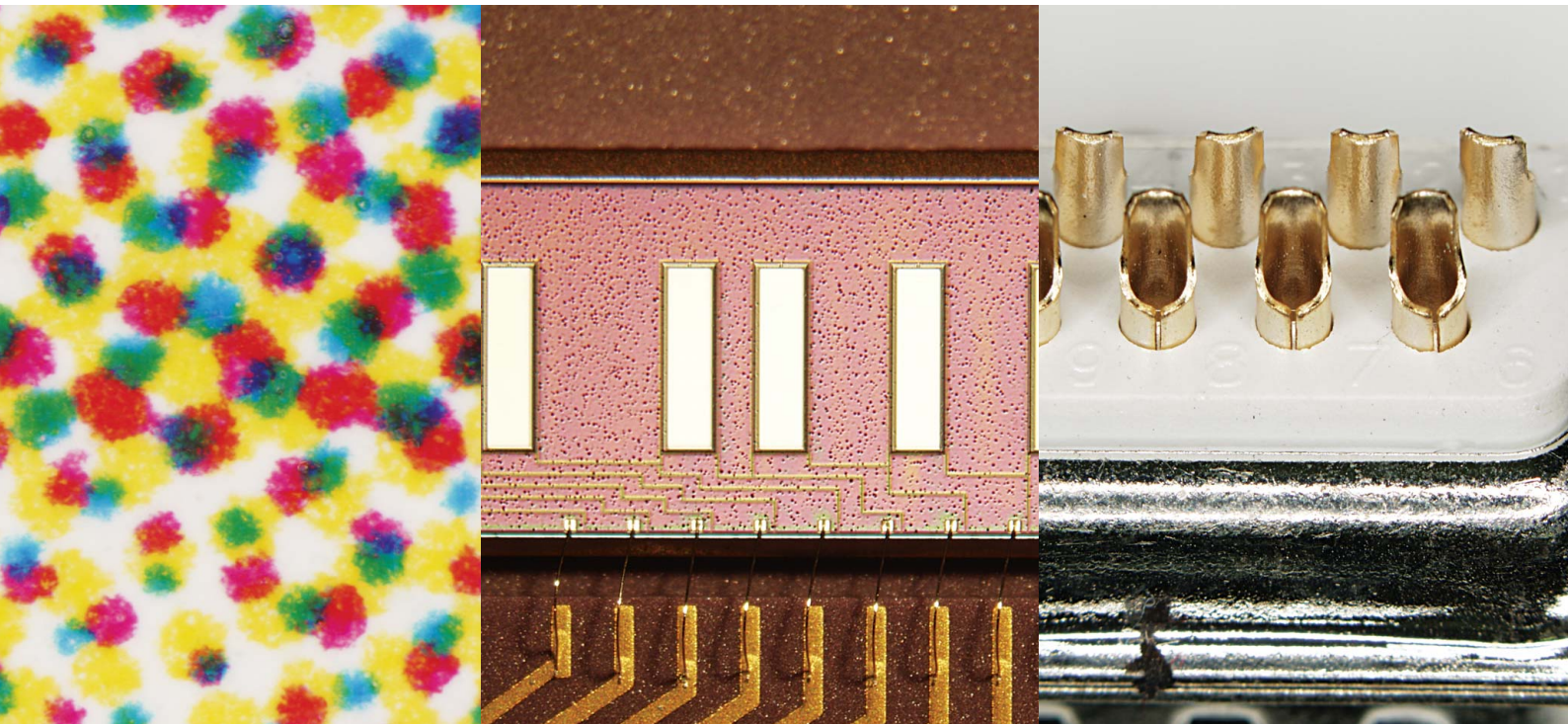

With advanced optics, superior quality, and an innovative ergonomic design, the SZX series is built to handle your industrial imaging needs. From observation to analysis to digital imaging, the SZX series meet SEMI standards while providing the increased efficiency and productivity required for industrial R&D and quality analysis.

■ Refined Optical Performance

SZX16 _____ P3–P6

SZX10 _____ P7–P8

■ Ergonomic Design for Working Comfort _____ P9–P10

■ Varied Illumination Technology _____ P11–P14

■ Intelligent Digital Imaging _____ P15–P17



SZX16 Standard base set



SZX10 Ergonomic set

By combining ergonomic instrumentation with the power of Galilean optics, the Olympus SZX series enables users to comfortably perform advanced stereomicroscopy tasks for extended periods of time. New ergonomic accessories bring the microscope closer to the user and provide flexibility for individuals of different heights. Providing a comfortable position for each user during microscope work reduces stress during observation and increases efficiency.

New levels of comfort are achieved without any reduction in image quality. The wide zoom range and increased focal depth optimize image quality and user productivity.

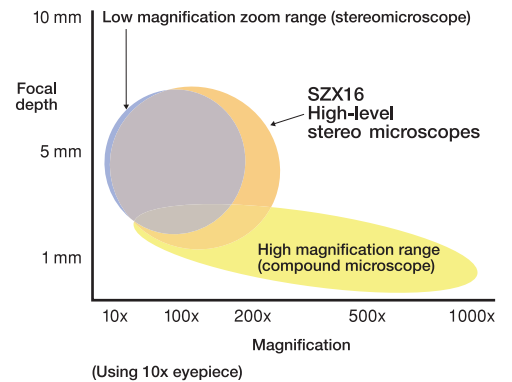

Refined Optical Performance Supports a Wide Zoom Range and Exceptional Image Clarity

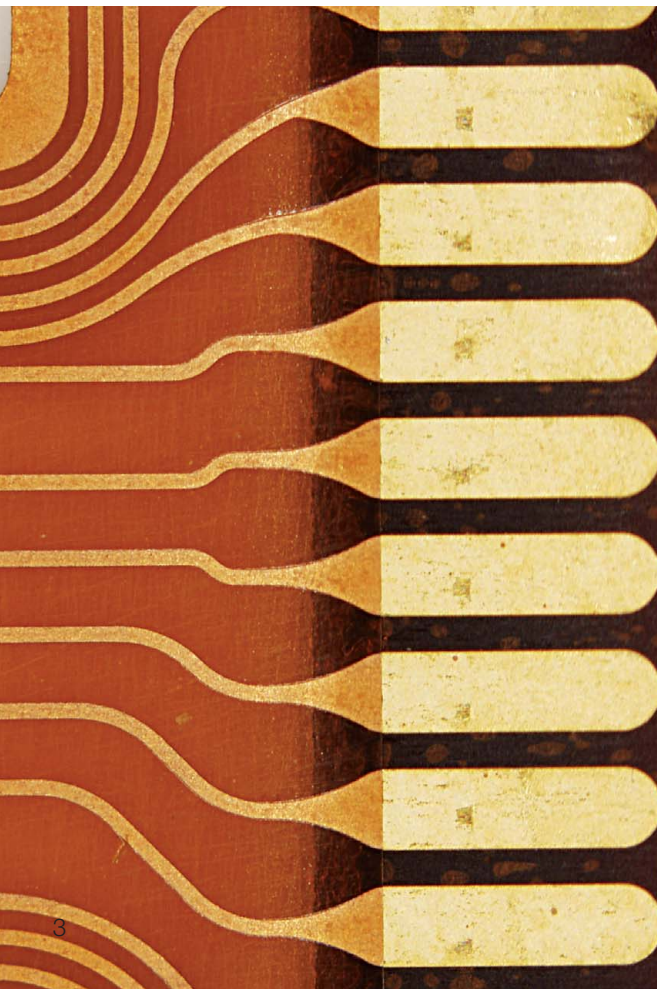

Wide Zoom Ratio (16.4:1) for Clear Viewing of Samples from Overview to Microstructural Observation

The SZX16 is crafted to the highest optical standards. With a wide zoom range of 0.7X–11.5X, clear observation ranging from overview to microstructure is possible. When revolving objectives are used, even higher resolution magnifications are available.

A Wide Zoom Ratio (16.4:1): Wide Range of Options for Observation and Documentation

At a zoom range of 0.7X–11.5X, seamlessly observe samples from overview to minute details.

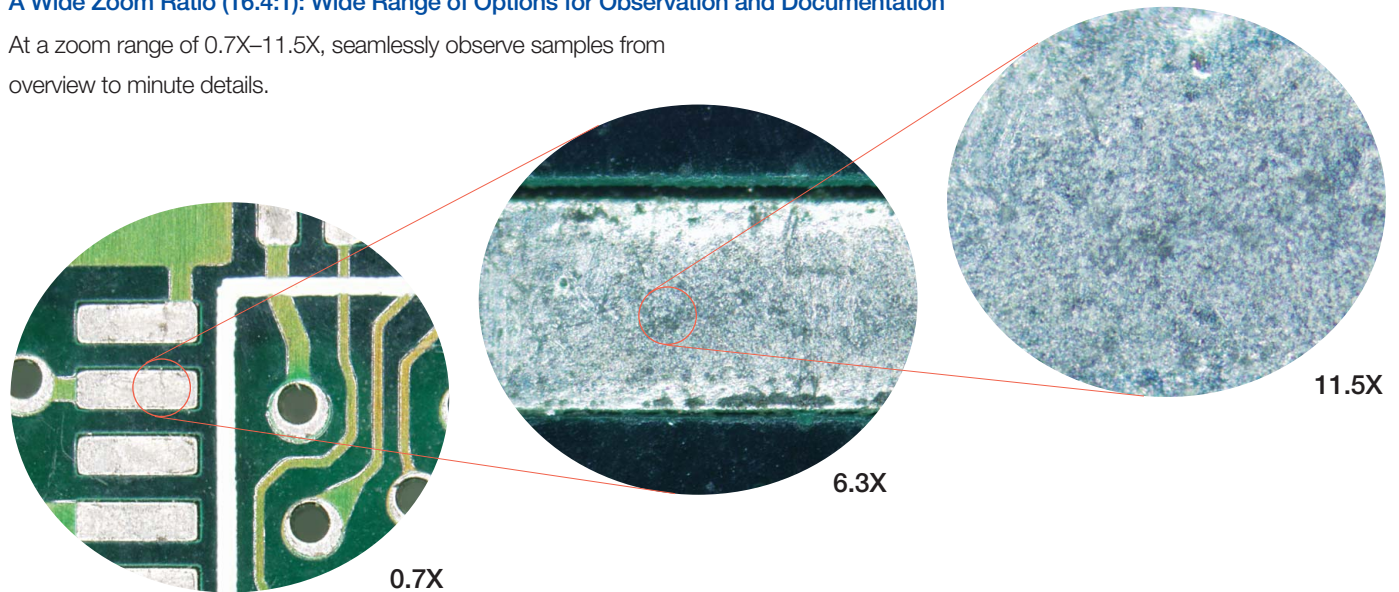

Improved Image Clarity at the Most Frequently Used Magnification

Resolution at the most frequently used magnification setting (middle range) is 30% better than previous Olympus stereo microscopes. Brightness is improved for high image clarity needed for research in advanced materials and electronics.

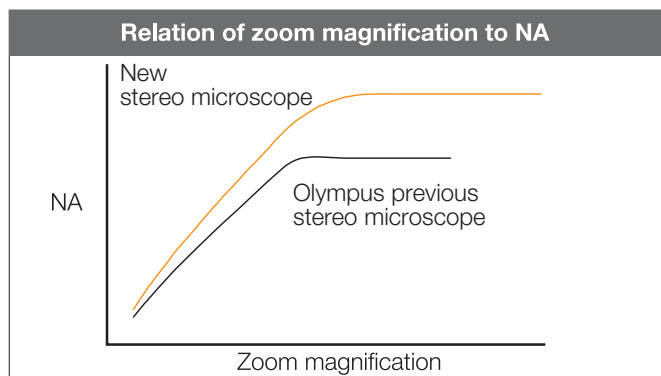

Expanded of Zoom Ratio with Revolving Nosepiece

The revolving nosepiece (SZX2-2RE16) incorporates parfocal (PF) objective lenses for observation at different magnifications. Using PF objective lenses enables quick and minimal focusing when switching between them.



Variable Focus Depth from the Built-in AS Zoom Body for Observation and Image Capture

The ability to control the built-in aperture stop (AS) enables the user to optimize sample viewing for contrast and resolution and is especially useful for samples that have uneven structures.

See More with New SDF (Super Depth of Focus) Series Objective Lenses

The six objective lenses in the new SDF lineup use special dispersion glass to provide outstanding stereoscopic viewing.

Leading-edge SDF Objectives

By effectively eliminating astigmatism, the SDF series achieves high-quality stereoscopic viewing with less defocusing. The six-piece lineup of 0.3X, 0.5X, 0.8X, 1X, 1.6X, and 2X objective lenses provide a wide range of observation between 2.1X–230X (with 10X eyepiece)—all conveniently available in one stereo microscope.



Top row, from right: SDFPLAPO2XPFC, SDFPLAPO1.6XPF, SDFPLAPO1XPF2
Bottom row, from right: SDFPLAPO0.8X, SDFPLAPO0.5XPF, SDFPLFL0.3X

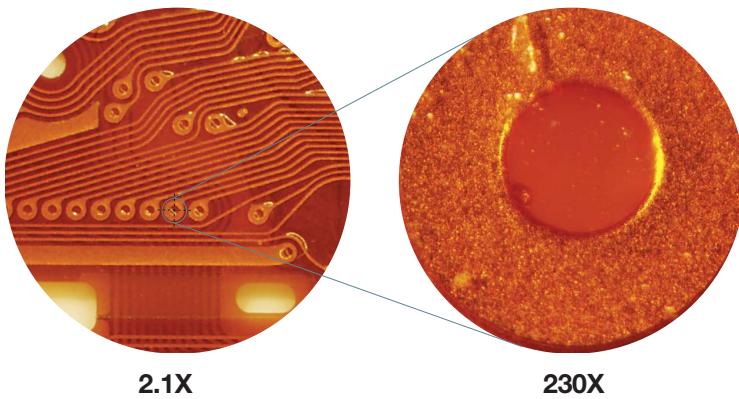

| Model | W.D. (mm) | Total magnification* |
|----------------|-----------|----------------------|
| SDFPLFL0.3X | 141 | 2.1X–34.5X |
| SDFPLAPO0.5XPF | 70.5 | 3.5X–57.5X |
| SDFPLAPO0.8X | 81 | 5.6X–92X |
| SDFPLAPO1XPF | 60 | 7X–115 |
| SDFPLAPO1.6XPF | 30 | 11.2X–184X |
| SDFPLAPO2XPFC | 20 | 14X–230X |

* Using 10x eyepieces; 15x through 30x eyepieces are optional.

High Resolution at 900 Lines/mm with SDFPLAPO2XPFC

SDFPLAPO2XPFC objective lens attains a high resolution at 900 lines/mm, resolved down to 1.1 μ m lines.

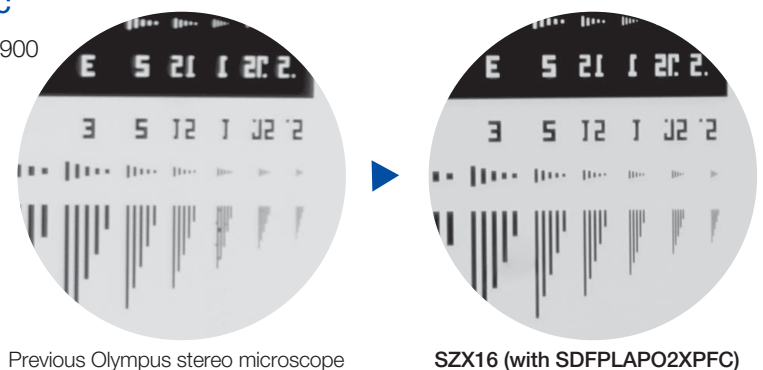

Previous Olympus stereo microscope

SZX16 (with SDFPLAPO2XPFC)

High NA (0.15) and Long W.D. (60 mm) with 1X Objective Lens

SDFPLAPO1XPF objective lenses provide both a high numerical aperture (NA) (0.15) and long working distance (60 mm).

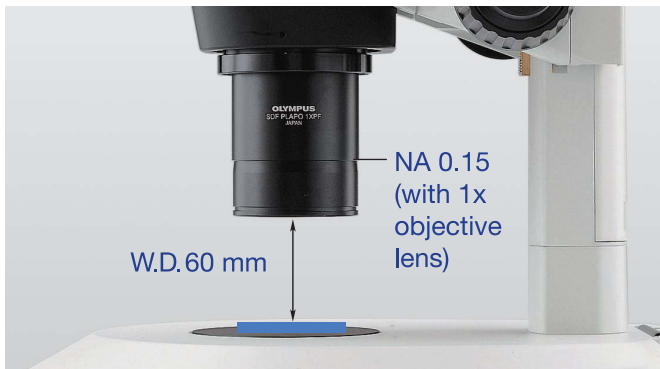

Achromatic Design Corrects for Chromatic Aberration

The characteristics of the apochromatic system—integrated into tubes, zoom body, and objective lenses—eliminate chromatic aberration and ensure excellent color reproduction for all zoom ranges.



Uncorrected apochromatic viewing

Apochromatic viewing

Astigmatism-free Design for Clear Stereoscopic View

An astigmatism-free design integrated throughout the system effectively prevents the astigmatism that deforms images appearing in tubes, zoom body, and objective lenses. Increased focus depth enables clear observation at high magnifications.



SZX16

Cost Efficiency Combined with Superior Performance and Outstanding Ease of Use

The SZX10 is a cost-effective stereo microscope that boasts excellent versatility and is easy to use. Two apochromatic objective lenses are standard. The 1X objective lens has an 81 mm working distance (W.D.) for operational comfort, and a 0.1 numerical aperture (NA) for excellent optical performance. The 1.25X objective lens is useful for many purposes. The chromatic-aberration correction of these objective lenses provides clear and distinct images.

High Zoom Ratio (10:1)

Olympus' proprietary optical design technologies are integrated throughout the microscope to achieve a high 10:1 zoom ratio of 0.63X–6.3X. Progress through a range of magnifications without switching objective lenses.

Built-in AS Zoom Body

The fully adjustable aperture stop (AS) can be used to increase focus depth; especially useful when observing tall samples.



Aperture stop of zoom body

New 1.25X Objective Lens for High Magnification and Resolution; 1X Objective Lens for Wider Field of View and Longer W.D.

These high-quality apochromatic lenses designed for the SZX10 are useful for a variety of observation tasks and applications.



Objective lenses: 1x for task efficiency



1.25x for high magnification and optimal NA

Distortion-Free Design Minimizes Image Curvature

A distortion-free design lowers curvature/distortion, enabling true observation of flat samples within a field of view.

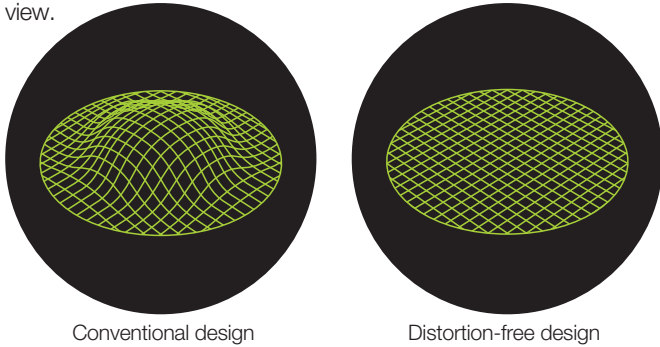

Conventional design

Distortion-free design

System-Wide Astigmatism-Free Design for Clear Observation

Incorporating an astigmatism-free design throughout the system effectively prevents the astigmatism that deforms tube, zoom, and objective lens images.

Selection of Powerful SZX10 Objective Lenses

Olympus objective lenses are designed to be equally responsive to different sample needs. Eight SZX10 objective lenses offer magnification from 0.5X to 2X. Users have a variety of observation choices all in a single microscope, ranging from 3.2X to 126X with 10x eyepieces. In addition, two lenses come standard with the revolving nosepiece (SZX2-2RE10).



SZX10



Top row, from right: DFPLA01.25X, DFPL1.5X-4, DFPL2X-4

Center row, from right: SZX-ACH1X, SZX-ACH1.25X-2

Bottom row, from right: DFPL0.5X-4, DFPL0.75X-4, DFPLA01X-4

| Model | W.D. (mm) | Total magnification* |
|----------------|-----------|----------------------|
| DFPL0.5X-4 | 171 | 3.2X–31.5X |
| DFPL0.75X-4 | 116 | 4.7X–47.3X |
| DFPLA01X-4 | 81 | 6.3X–63X |
| SZX-ACH1X | 90 | 6.3X–63X |
| DFPLA01.25X | 60 | 7.9X–78.9X |
| SZX-ACH1.25X-2 | 68 | 7.9X–78.9X |
| DFPL1.5X-4 | 45.5 | 9.5X–94.5X |
| DFPL2X-4 | 33.5 | 12.6X–126X |

* Using 10x eyepieces; 15x through 30x eyepieces are optional.

Ergonomic Instrumentation Increases User Comfort During Extended Work Sessions



Tilting Trinocular Observation Tubes with Optimized Convergence Angle Minimize Eye and Neck Strain

Trinocular tubes provide comfortable and efficient observation.

Whether seated or standing, observers can adjust the tilting trinocular tube to efficiently perform long-duration observation.

Natural Posture, Reduced Stress, and Increased Productivity

The ergonomic long tilting trinocular provides an optimized work position for individual users by bringing the microscope closer to the user, while the extendable eyepoint adjuster provides flexibility for users of different heights. The SZX series' ergonomic instruments reduce stress during observation by providing the most comfortable position for each user, increasing efficiency of work.

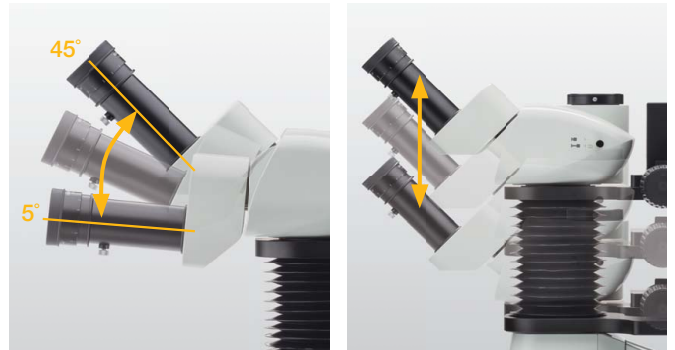

Tilting range of SZX2-TTR

SZX2-EEPA

Convergence Angle in Tube Relieves Eyestrain

Olympus' research established a correlation between stereomicroscopic optical systems and eyestrain. A convergence angle using right and left optical paths without compensation can induce discomfort. The convergence angle in the SZX series, however, completely compensates for each optical path. This solution effectively eliminates eyestrain during prolonged observation.

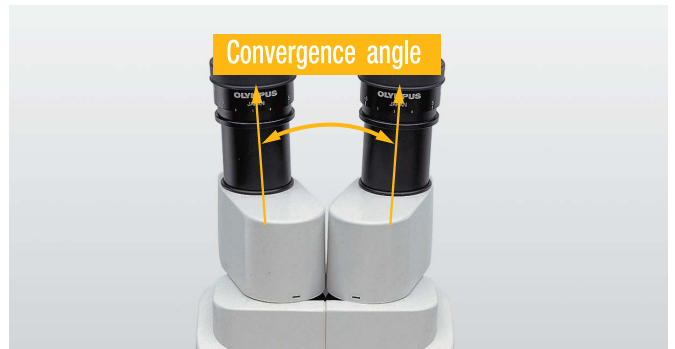

Ergonomic Zoom and Focus Knobs for Fatigue-Free Use

Position of zoom knob, size and position of coarse/fine focusing knob, and the fine focus stroke have all been redesigned for easier operation. This enhancement of the fine focus stroke results in easy and precise focusing.



Ergonomic coarse/fine focusing knob

Slim Design Illumination Stand for Easy Access to Samples

Illumination stands are designed to not only be easy to use, but also fatigue-free. The slim LED transmitted light illumination stand, at approximately 40 mm in height, features easily adjustable fingertip illumination control and provides easy access to samples.



Slim design illumination stand (SZX2-ILLT)

Long-Life LED Illumination Faithfully Reproduces Colors for Optimal Imaging

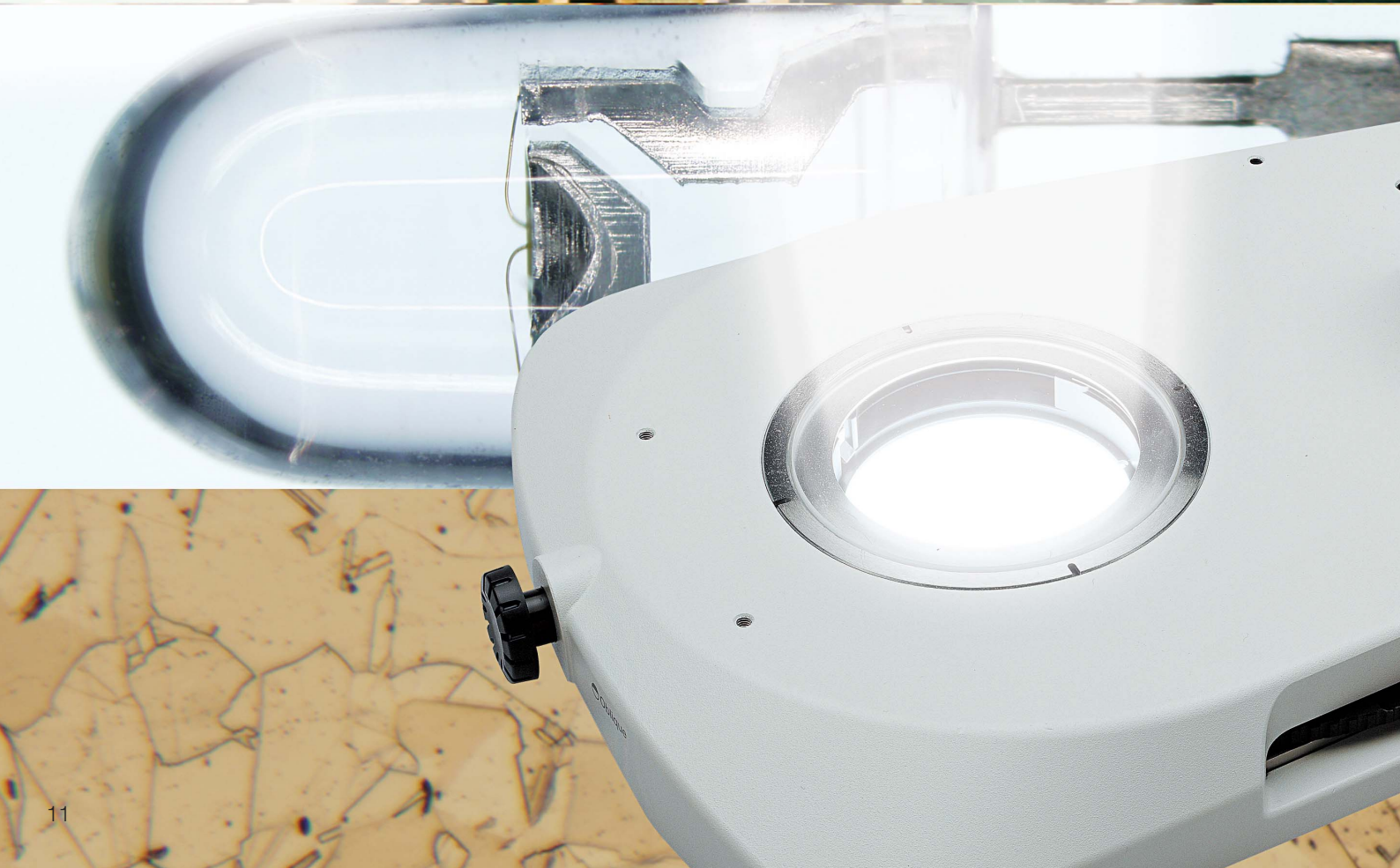
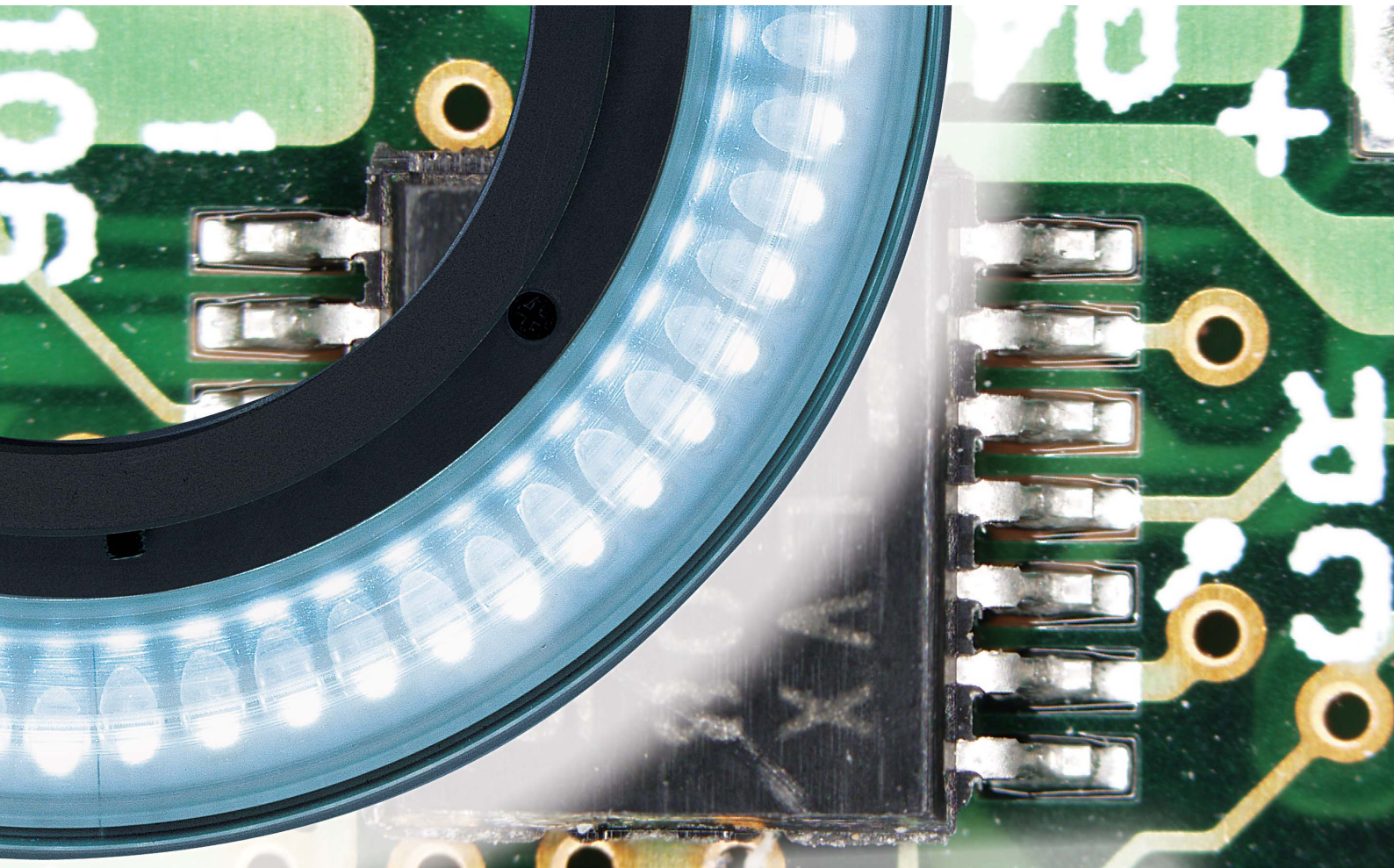

Industrial research requires the precision that LED illumination provides for a variety of inspection and sample needs. Reproducing natural light, white LED delivers constant color temperature, and the LED ring illuminator offers high contrast observation and variable lighting for ease of use. Olympus' long-life LEDs reduce maintenance and improve imaging results.

LED Four-Part Ring Illumination Unit (SZX2-ILR66)

High-intensity LED illumination is an extremely bright light source that reproduces natural light for optimal observation. This LED illumination system provides even illumination plus a variable selection of lighting for ease of use. By choosing from an illuminator divided into four lighting zones, users can choose full, 3/4, 1/2, and 1/4 lighting for a total of thirteen patterns; the user does not need to move the sample for optimal viewing and documentation. Thanks to fan-less ventilation of the power supply, the LED illumination system is compatible with clean rooms. In addition to ESD compatibility that helps keep samples free from static electricity damage, the manual control unit is easily operated by hand, providing user comfort.



The exclusive control for the LED ring illumination system offers the freedom to direct 13-pattern LED lighting for optimum observation. 3/4, 1/2, and 1/4 lighting patterns move in circular rotation and in mirror symmetry via pad control. The ergonomic design of the unit is perfectly suited to fingertip operation.



SZX2-RHS, the control pad for LED 4-part ring illumination unit



Four-part illumination of surface fracture (metal)

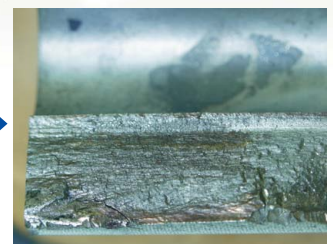

Upper-portion illumination of surface fracture (metal)

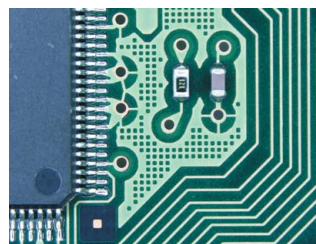

Four-part illumination of PWB

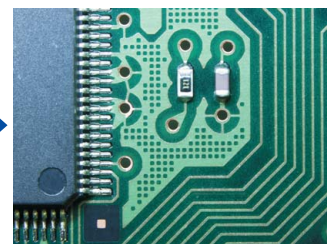

Right-quadrant illumination of PWB

Slim LED Transmitted Light Illumination Stand (SZX2-ILLT)

This LED transmitted light illumination stand provides three image contrast options in a slim design. In addition to superior darkfield performance, LEDs (with a product life of over 10,000 hours) facilitate crisp brightfield images and contrast-enhancing oblique illumination.



Slim LED transmitted light illumination stand

Choose the Illumination Source That Suits Your Sample

Olympus' light solutions work for many different tasks with sources such as transmitted, reflected, ring light, and fluorescence illumination. Offering consistently bright and stable illumination, the SZX system meets reflected light requirements with a coaxial illumination system, a dual flexible light guide, and a ring light guide, among others. These choices enable users to do a broad array of stereo microscope observations and documentation.

Various Reflected Light Illumination Systems

Dual Combination Light Guide (LG-DFI)

The top-mounted dual light guide is easy to position and keeps workspaces uncluttered. This system maintains the selected



Dual contrast light guide on SZX16

Coaxial Illumination System (SZX2-ILLC16/SZX2-ILLC10)

This illumination system is ideal for detecting imperfections on highly reflective samples such as ICs, photonic products, and medical devices. Also available is the SZX2-ILD coaxial illumination unit with SZX2-ILPS power supply, featuring an LED light source. It not only has low power consumption but is maintenance-free and eco-friendly. Thanks to minimal vibration and a dust-free design, the unit is well-suited for clean rooms.

Dual Combination Light Guide (LG-DFI)

This ring light guide provides bright, clear, and even illumination from several angles, thus eliminating obstructive sample shadowing.



Ring light guide on SZX16

Objective Lenses with an Access Angle of 51 Degrees

(Objective Lenses for SZX16: SDFPLAPO1.6XPF, SDFPLAPO2XPFC)

Light-guide illumination with short working distance (W.D.) objective lenses make effective illumination difficult. Objective lenses set at 1.6X and 2X with a 51-degree access angle enable optimum illumination.



SZX16 Coaxial illuminator

SZX16 LED Coaxial illuminator

Dual Combination Light Guide (LG-DFI)

With this unit, users can view select areas with pinpoint accuracy and optimal viewing conditions.



Transmitted Light Illumination in the following Three Stands

Advanced Brightfield Transmitted Light Illumination Stand with Filters (SZX2-ILLB)

A proprietary oblique illumination design delivers high contrast for transparent samples. High and low power imaging provide further contrast enhancement. Three built-in filters (ND6/ ND25/LBD) deliver stable color temperature illumination.



Advanced transmitted light illumination stand (SZX2-ILLB)

Brightfield/Darkfield Transmitted Light Illumination Stand (SZX2-ILLD)

This transmitted light illumination stand provides twice the usual intensity with even illumination, while maintaining a safe temperature level on the surface of the illumination stand.



Transmitted Light Illumination Stand (SZX2-ILLK)

Distinguished cost-effective performance that is especially suitable for 1X objective lenses. Adjustable oblique illumination provides the contrast needed for optimal observation of transparent samples.



SZX16-RFA Fluorescence Light Illumination System for Advanced Fluorescence Imaging

High NA Provides Bright Fluorescent Observation

A near-vertical reflected light illumination system produces illumination that is almost coaxial to the observation path and enables substantially improved excitation light efficiency. These features provide an average of two to three times better fluorescent observation than conventional stereo microscopes at all magnifications. In addition to using reflected light, transmitted light can also be used for sample confirmation.

Five-position Turret with Five-filter Selection

The fluorescence illumination system for the SZX16 has five-position turrets with a five-filter selection for different samples. Eleven different fluorescent filter units capture the details of bright and high-contrast fluorescent images.



Enhanced Power with Sophisticated Digital Cameras and Image Analysis Software



Digital technology is a total synergy of Olympus optics, microscope digital camera, and image analysis software. Vertical observation provides excellent images.

High-Resolution Digital Camera DP73

This 17.3-megapixel cooled digital camera with pixel-shift technology boasts excellent resolving power, sensitivity, and precise 14-bit (16384 steps) color fidelity. The DP73 is compatible with all light microscopic observation methods and produces contrast balanced images using a unique dynamic range technology. ISO1600 sensitivity delivers clear display even for faint fluorescence signals. A high definition 1600 x 1200-pixel image can be displayed live at a rate of 15 frames-per-second, without compression, and a maximum 4800 x 3600-pixel image can be instantly saved.



Digital Camera DP27

This high-resolution 5-megapixel color CCD camera provides optimum true color performance for all industrial applications and imaging techniques. The DP27 incorporates high speed progressive scanning with USB 3.0 connectivity.



High-speed, Compact Digital Camera DP22

This 2.8-megapixel color CCD camera can be used as a complete stand-alone model (no PC required). The control box incorporates the 12 most frequently used measurement functions for efficient inspection of industrial parts, providing smooth and intuitive operation via a touch-screen monitor or a mouse.



Vertical observation

The revolving nosepieces for SZX16 (SZX2-2RE16) and SZX10 (SZX2-2RE10) may be used for standard stereomicroscopic observation as well as vertical observation, which accommodates the overlap of lens center and optical axis. Lens-centered observation results in aberration-free images. Defocusing is effectively eliminated for 3D rendering by image processing software.



The nosepiece enables vertical observation.

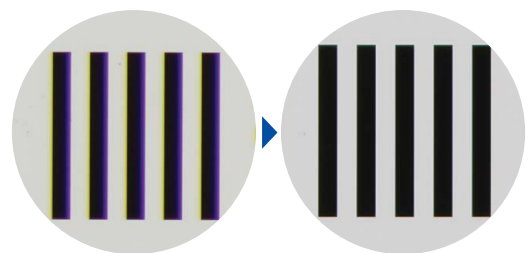

Ordinary observation (image)

Vertical observation (image)

OLYMPUS Stream Micro-Imaging Software: A New Standard for Workflow Flexibility

The OLYMPUS Stream image analysis software enables you to seamlessly acquire images, process, and measure them via a stereo microscope with a digital camera. The system provides you with the flexibility to meet your needs without changing your operation. You can execute not just simple measurements, but panoramic view, extended focus, and particle analysis.

Optimized Focus and Exposure

The OLYMPUS Stream focus indicator enables users to select a region of interest and bring it into optimum focus using the focus control of the microscope. This function is essential when a large optical depth of field makes it difficult to find the best focus position by eye. OLYMPUS Stream's live histogram display and overexposure indicator make it easy to find the optimum exposure time to avoid overexposed images that cause a loss of detail. Your digital camera's exposure time can then be adjusted manually or automatically when using the family of Olympus DP series cameras.

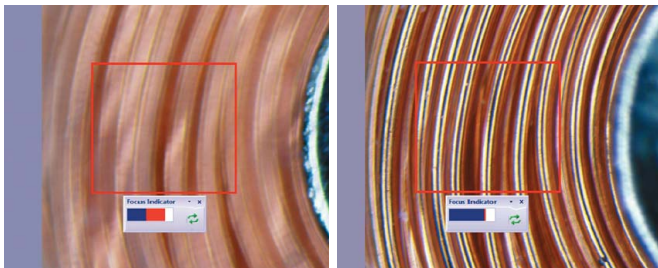

Unfocused

Focused

Instant Extended Focus Image (EFI)

OLYMPUS Stream software provides images for samples that extend beyond the standard depth of focus. The instant Extended Focus Image enables you to use the fine focus adjustment to combine many images at different z-levels to provide you with a single combined image that is entirely in focus.

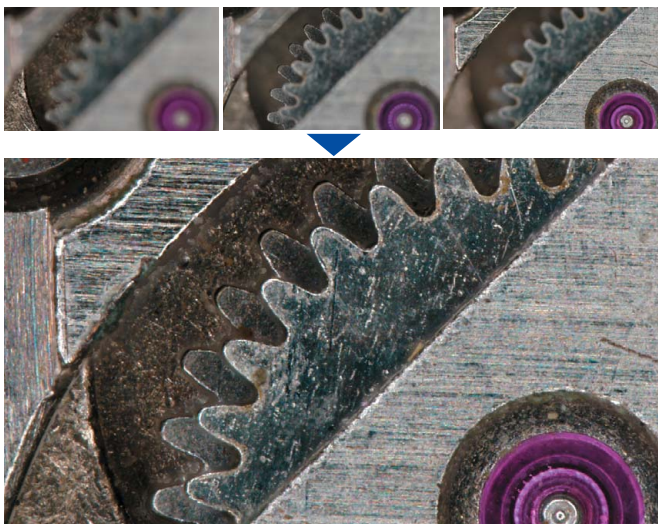

Perfectly focuses image of mechanical parts of a watch

Manual Multiple Image Alignment (MIA)

OLYMPUS Stream software provides Multiple Image Alignment (MIA) for the creation of panoramic images of samples that extend beyond the field of view. The OLYMPUS Stream software quickly stitches them together, providing you with an output ready for visualization or complex measurement. Simultaneous use of instant EFI is also possible.

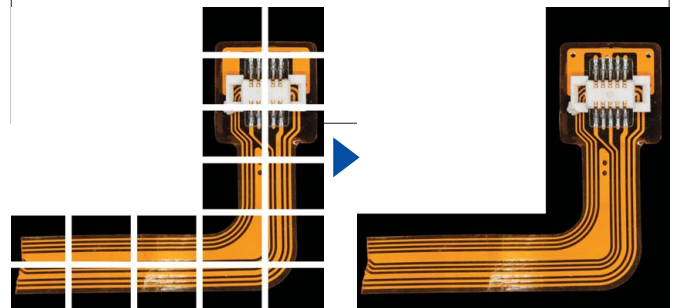

Multiple image acquisition of a flexible board

Count and Measure

Object detection and size distribution measurement are among the most important applications in digital imaging. OLYMPUS Stream incorporates a detection engine that utilizes threshold methods to reliably separate objects (e.g. particles, scratches) from the background. OLYMPUS Stream offers more than 50 different parameters for shape, size, position, and pixel properties (intensity, gray value) for object classification.

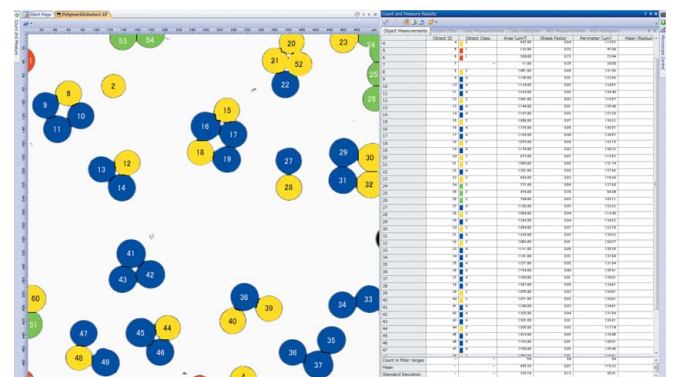

Object detection and classification

Please refer to OLYMPUS Stream catalog for further details

A Range of Accessories to Extend the Width of Observation. Customizable for Various Purposes (SZX16 / SZX10)



SZX16 Universal stand

Universal Stand with ESD* Compatibility (SZX-STU2)

This stand is designed for observation and digital imaging of samples too large for standard-size stands. The design, based on dual horizontal poles and linear ball bearings, ensures smooth horizontal movement and rotation. The mechanism can be tilted forward, backward, right, and left, enabling a quick and precise approach to the chosen observation area.

*ESD = Electric Static Discharge



SZX16 Large stand

Large Stand (SZX2-STL)

This large stand exhibits excellent stability, making it optimized for image capture as well as observation of large samples.



SZX16 Motorized zoom and focus unit

Motorized Focus and Zoom Enhance Efficiency (Motorized Focus Unit SZX2- FOA/Motorized Zoom Unit SZX2-ZB16A)

The motorized focus unit has a maximum load capacity of 23 kg and facilitates operation when heavy items, such as cameras, are attached. With the addition of motorized zoom, both focusing and zooming can be performed with one hand via an easily accessed switch—the ideal solution for improving examination efficiency. Remote operation is also possible, enabling observation on an external monitor.



U-SRG, SZX-STAD1

BX Stage Adapter type 1 (SZX-STAD1)

Enables use of the BXiS rotating stage (U-SRG) with various SZX stands and transmitted light illuminators. This is especially valuable in polarized observations and image capture.



U-SIC4R2, U-MSSPG, U-MSSP4, SZX-STAD-2

BX Stage Adapter type 2 (SZX-STAD2)

Enables use of a BXiS mechanical stage with various SZX stands and transmitted light illuminators. Particularly suitable for accurate X-Y movement of samples.

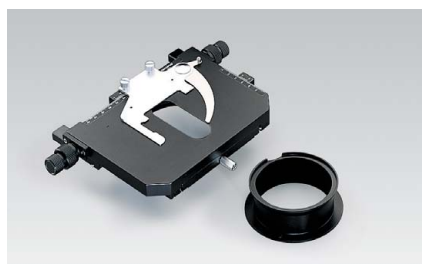

BH2-SH, SZH-STAD1

BH Stage Adapter type 1 (SZH-STAD1)

Enables use of a BH2 mechanical stage (BH2-SH) with various SZX stands and transmitted light illuminators. Particularly suitable for accurate X-Y movement of samples.



Specifications

SZX16/SZX10 SPECIFICATIONS

| Item | Specifications | | | | | |
|----------------------|---|-----------------|-----------|--|-----------------|-----------|
| | SZX2-ZB16/SZX2-ZB16A | | | SZX2-ZB10 | | |
| Zoom microscope body | Zoom ratio: 16.4 (0.7X–11.5X) Magnification indication: 0.7/0.8/1/1.25/1.6/2/2.5/3.2/4/5/6/3/8/10/11.5 | | | Zoom ratio: 10 (0.63X–6.3X) Magnification indication: 0.63/0.8/1/1.25/1.6/2/2.5/3.2/4/5/6.3 | | |
| | Zoom variable magnification system with parallel optical axis Zoom drive system: Horizontal handle click-stop for various zoom positions incorporated | | | | | |
| | Motorized zoom body (SZX2-ZB16A), Manual zoom body (SZX2-ZB16, SZX2-ZB10) | | | | | |
| | AS: Built-in Objective mounting: screw mount | | | | | |
| Objective | For SZX2-ZB16/SZX2-ZB16A | | | For SZX2-ZB10 | | |
| | Objectives | NA | W.D. (mm) | Objectives | NA | W.D. (mm) |
| | SDFPLFL0.3X | 0.045 | 141 | DFPL0.5X-4 | 0.05 | 171 |
| | SDFPLAPO0.5XPF | 0.075 | 70.5 | DFPL0.75X-4 | 0.075 | 116 |
| | SDFPLAPO0.8X | 0.12 | 81 | DFPLAPO1X-4 | 0.1 | 81 |
| | SDFPLAPO1XPF | 0.15 | 60 | SZX-ACH1X | 0.1 | 90 |
| | SDFPLAPO1.6XPF | 0.24 | 30 | DFPLAPO1.25X | 0.125 | 60 |
| | SDFPLAPO2XPF | 0.3 | 20 | SZX-ACH1.25X-2 | 0.125 | 68 |
| Eyepiece | WHN10X-H FN 22 | WHSZ15X-H FN 16 | | WHSZ10X-H FN 22 | WHSZ15X-H FN 16 | |
| | WHSZ20X-H FN 12.5 | WHSZ30X-H FN 7 | | WHSZ20X-H FN 12.5 | WHSZ30X-H FN 7 | |
| Observation tube | SZX2-TTR/SZX2-TTRPT: Tilting trinocular tube Convergence angle, Tilting angle: 5°–45°, Interpupillary distance adjustment: 52–76 mm, 2 steps optical path selectable (TTR observation: straight port = 100:0, 50:50) (TTRPT observation: straight port = 100:0, 0:100) | | | | | |
| | SZX2-TR30/SZX2-TR30PT: 30 degree trinocular tube Convergence angle, Tilting angle: 30°, Interpupillary distance adjustment: 52–76 mm, 2 steps optical path selectable (TR30 observation: straight port = 100:0, 50:50) (TR30PT observation: straight port = 100:0, 0:100) | | | | | |
| | SZX2-LTTR: Ergonomic Long Tilting Trinocular** Convergence angle, Tilting angle 5°–45°, Interpupillary distance adjustment: 57–80 mm, 2 steps optical path selectable (straight port = 100:0, 50:50) | | | | | |
| | — | | | SZX-BI30: 30° binocular tube Tilting angle: 30° Interpupillary distance adjustment: 51–76 mm | | |
| Focusing assembly | SZX2-FO: Focusing unit / focus: rack and pinion with roller guide (with torque adjustment ring for coarse focusing), optional counter balance, coarse handle stroke: 80 mm, coarse handle stroke per rotation: 21 mm, Load capacity: 0–10.0 kg | | | | | |
| | SZX2-FOF: Fine focusing unit / focus: rack and pinion with roller guide (with torque adjustment ring for coarse focusing), coarse and fine coaxial handle, built-in counter balance, coarse handle stroke: 80 mm, coarse handle stroke per rotation: 36.8 mm, fine handle stroke: 80 mm, fine handle stroke per rotation: 0.77 mm, load capacity: 2.7–15.0 kg | | | | | |
| | SZX2-FOFH: Fine focusing unit for heavy loading / focus: rack and pinion with roller guide (with torque adjustment ring for coarse focusing), coarse and fine coaxial handle, built-in gas spring counter balance, coarse handle stroke: 80 mm, coarse handle stroke per rotation: 36.8 mm, fine handle stroke: 80 mm, fine handle stroke per rotation: 0.77 mm, load capacity: 8.0–25.0 kg | | | | | |
| | SZX2-FOA: Motorized focus unit / focus: rack and pinion with roller guide, focusing stroke: 78 mm, motorized focusing speed coarse: 2.7 mm/s, fine: 0.27 mm/s load capacity: 0.0–23.0 kg | | | | | |
| | SZX2-EEPA: Height adjustment range: 30–150 mm (with a scale attached) | | | | | |
| Stand | SZX2-ST: Standard stand / Pillar height: 270 mm, base dimension (W × D × H) : 284 mm × 335 mm × 31 mm, Stage clips are mountable, with stage adapter fixing screw holes | | | | | |
| | SZX2-STL: Large stand / Pillar height: 400 mm, base dimension (W × D × H) : 400 mm × 350 mm × 28 mm, Stage clips are mountable, with stage adapter fixing screw holes | | | | | |

** SZX2-LTTR: intermediate magnification is 1.25X.

TRANSMITTED ILLUMINATION BASE SPECIFICATIONS

| Item | Specifications | | | |
|---|--|--|--|--|
| | SZX2-ILLT | SZX2-ILLB | SZX2-ILLK | SZX2-ILLD |
| Light source | LED (Average service life: over 10,000 hrs by rated use.) | 6 V 30 W Halogen 6 V 30 W HAL PHILIPS 5761 (average lamp service life: approx. 100 hours by rate use.) | | |
| Light intensity adjustment | Continuously variable system | | | |
| Effective illuminated area | Brightfield: ø63 mm Darkfield / Oblique: ø35 mm | ø40 mm | | Brightfield: ø40 mm Darkfield: ø35 mm |
| Built-in filter | — | LBD, ND6, ND25 one for each | — | LBD (bright field only) |
| Add-on filter | — | — | ø45LBD filter | — |
| Illumination mode | Brightfield illumination Oblique illumination Darkfield illumination | Brightfield illumination Oblique illumination | Brightfield illumination Oblique illumination | Brightfield illumination Darkfield illumination |
| Contrast selection | — | 2-step selection of High and Low | | — |
| Cooling fan | — | Built-in | | |
| The height of stage (from desk surface) | 41 mm | 82 mm | | |
| Pillar height | 270 mm | | | |
| Weight | Approx. 3.7 kg | Approx. 5.0 kg | Approx. 4.6 kg | Approx. 5.4 kg |
| Power source | AC 100–240 V 50/60 Hz (AC adapter) | | | |

TRANSMITTED ILLUMINATION BASE SPECIFICATIONS

| Type | LED ring illuminator SZX2-ILR66 | Ring light guide LG-R66 | Dual ring light guide LG-DFI/DI | Coaxial illuminator SZX2-ILLC16/10 |
|-----------------------------|---|--|---|---|
| Features | 4-part LED ring illumination 4-part independent ON/OFF available | Bright, uniformly lit images without glaring reflections or obscuring shadows | Flexible illumination for any angle and position | Bright high contrast coaxial illumination. Effective for observing structure, such as imperfections on metal surfaces, patterns on IC or LCD |
| Illumination specifications | Rotary, mirror function, ESD capability, RoHS compatibility, Class 1 | Minimum W.D.: 30 mm Installation diameter: 66 mm Flexible part: 1000 mm Attachment adapter*: SZX-LGR66 *No adapter required for SZX16-LGR66 *Unable to attach to SDFPLAPO2XPFC/ SDFPLAPO1.6XPF | LG-DFI: Flexible part 900 mm Inter-lock part 500 mm LG-DI: Inter-lock part 500 mm | Magnification factor: 1.5X Light guide: LG-DF Flexible part 1000 mm 1/4 wavelength retardation plate included |
| Light source specifications | 10-segment light intensity volume, fan-less ventilation, AC 100–240 V | Type: LG-PS2 Functions: Light intensity control and lamp ON/OFF control by external signal (DC 0-5 V), mechanical adjustment function Power consumption: 150 W (350 VA) Rated voltage: AC 100–120 V/220–240 V 50/60 Hz 3.0 A/1.8 A Dimensions (W × H × D): 126 mm × 131.4 mm × 251 mm Weight: approx. 1.7 kg | | |
| Option | SZX-LGR66, adapter for SZX10 | LG-R66PL: Polarizer/analyzer set for LG-R66 | HILL301: spot lens | — |

TOTAL MAGNIFICATIONS AND ACTUAL FIELD DIAMETERS OF SZX2-ZB16/SZX2-ZB16A*1

| Objective | Eyepiece | | | | | | | |
|----------------|------------|---------------------|--------------|---------------------|------------|---------------------|--------------|---------------------|
| | WHN10X-H | | WHSZ15X-H | | WHSZ20X-H | | WHSZ30X-H | |
| | total mag. | field diameter (mm) | total mag. | field diameter (mm) | total mag. | field diameter (mm) | total mag. | field diameter (mm) |
| SDFPLFL0.3X | 2.1X–34.5X | ø104.8–ø6.4 | 3.2X–51.8X | ø76.2–ø4.6 | 4.2X–69X | ø59.5–ø3.6 | 6.3X–103.5X | ø33.3–ø2.0 |
| SDFPLFL0.5XPF | 3.5X–57.5X | ø62.9–ø3.8 | 5.3X–86.3X | ø45.7–ø2.8 | 7X–115X | ø35.7–ø2.2 | 10.5X–172.5X | ø20.0–ø1.2 |
| SDFPLAPO0.8X | 5.6X–92X | ø39.3–ø2.4 | 8.4X–138X | ø28.6–ø1.7 | 11.2X–184X | ø22.3–ø1.4 | 16.8X–276v | ø12.5–ø0.8 |
| SDFPLAPO1XPF | 7X–115X | ø31.4–ø1.9 | 10.5X–172.5X | ø22.9–ø1.4 | 14X–230X | ø17.9–ø1.1 | 21X–345X | ø10.0–ø0.6 |
| SDFPLAPO1.6XPF | 11.2X–184X | ø19.6–ø1.2*2 | 16.8X–276X | ø14.3–ø0.9 | 22.4X–368X | ø11.2–ø0.7 | 33.6X–552X | ø6.3–ø0.4 |
| SDFPLAPO2XPFC | 14X–230X | ø15.7–ø1*2 | 21X–345X | ø11.4–ø0.7*2 | 28X–460X | ø8.9–ø0.5 | 42X–690X | ø5.0–ø0.3 |

*1 SZX2-LTTR: intermediate magnification is 1.25X *2 Some vignetting may occur from optical characteristics. This occurs in observations at low magnification.

TOTAL MAGNIFICATIONS AND ACTUAL FILED DIAMETERS OF SZX2-ZB10*3

| Objective | Eyepiece | | | | | | | |
|--------------------------------|------------|---------------------|--------------|---------------------|--------------|---------------------|--------------|---------------------|
| | WHN10X-H | | WHSZ15X-H | | WHSZ20X-H | | WHSZ30X-H | |
| | total mag. | field diameter (mm) | total mag. | field diameter (mm) | total mag. | field diameter (mm) | total mag. | field diameter (mm) |
| DFPL0.5X-4 | 3.2X–31.5X | ø69.8–ø7.0 | 4.7X–47.3X | ø50.8–ø5.1 | 6.3X–63X | ø39.7–ø4 | 9.5X–94.5X | ø22.2–ø2.2 |
| DFPL0.75X-4 | 4.7X–47.3X | ø46.6–ø4.7 | 7.1X–70.9X | ø33.9–ø3.4 | 9.4X–94.5X | ø26.5–ø2.6 | 14.2X–141.8X | ø14.8–ø1.5 |
| DFPLAPO1X-4 SZX-ACH1X | 6.3X–63X | ø34.9–ø3.5 | 9.5X–94.5X | ø25.4–ø2.5 | 12.6X–126X | ø19.8–ø2 | 18.9X–189X | ø11.1–ø1.1 |
| DFPLAPO1.25X SZX-ACH1.25X-2 | 7.9X–78.9X | ø27.9–ø2.8 | 11.8X–118.1X | ø20.3–ø2 | 15.8X–157.5X | ø15.9–ø1.6 | 23.6X–236.3X | ø8.9–ø0.9 |
| DFPL1.5X-4 | 9.5X–94.5X | ø23.3–ø2.3 | 14.2X–141.8X | ø16.9–ø1.7 | 18.9X–189X | ø13.2–ø1.3 | 28.4X–283.5X | ø7.4–ø0.7 |
| DFPL2X-4 | 12.6X–126X | ø17.5–ø1.7 | 18.9X–189X | ø12.7–ø1.3 | 25.2X–252X | ø9.9–ø1 | 37.8X–378X | ø5.6–ø0.6 |

*3 SZX2-LTTR: intermediate magnification is 1.25X

Dimensions

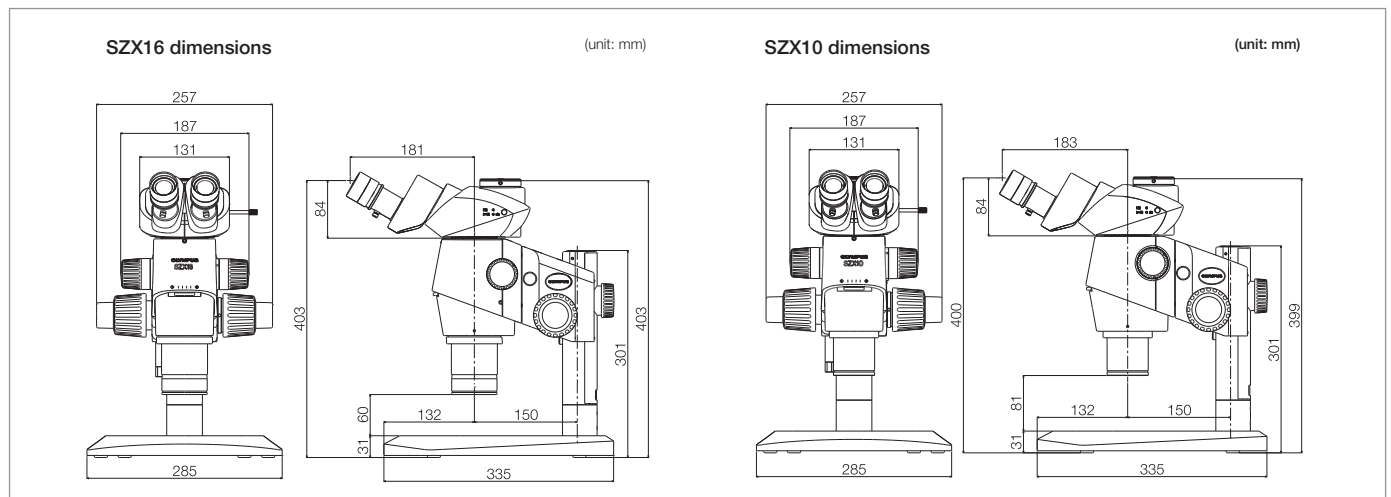

System Diagram

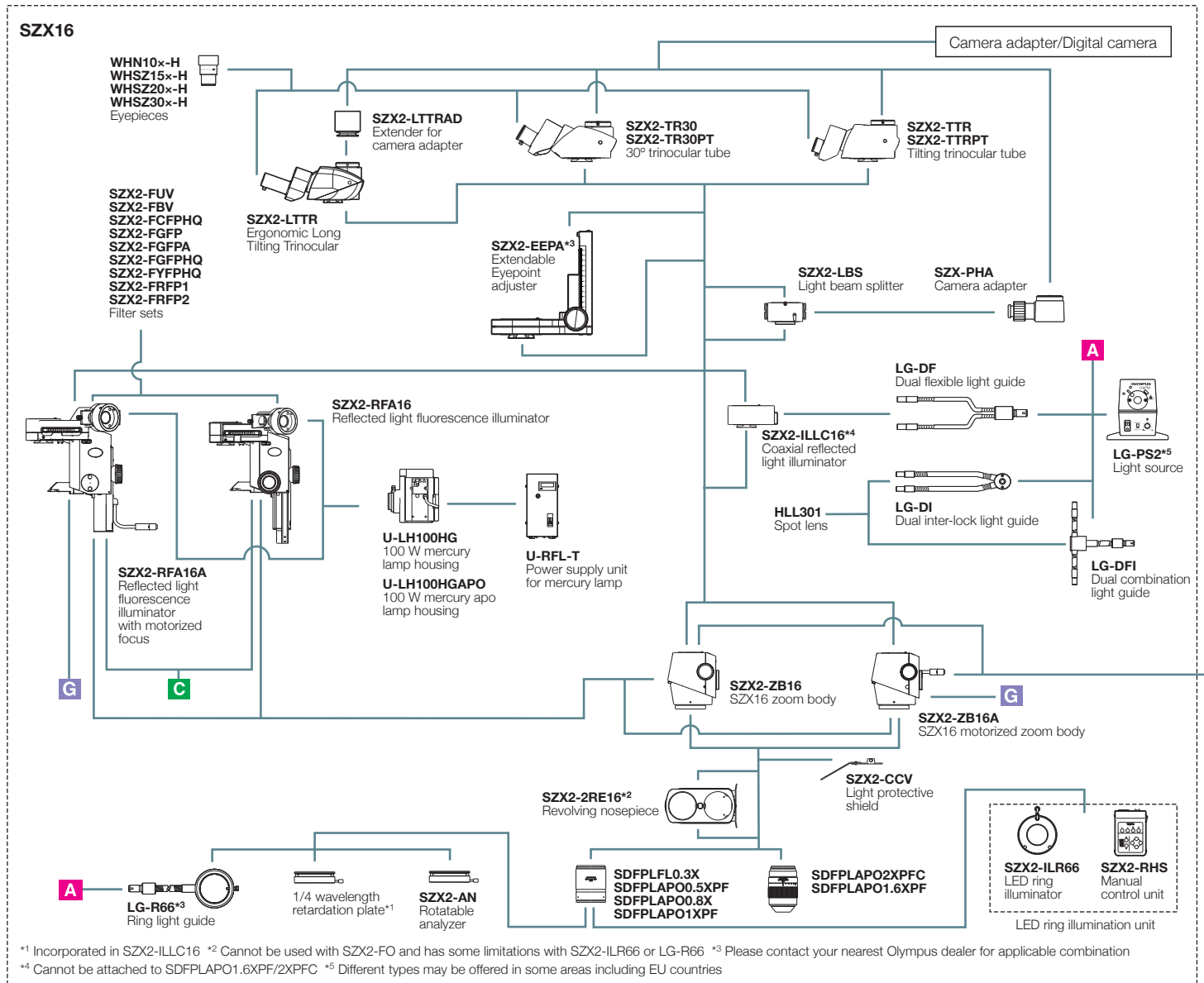

*1 Incorporated in SZX2-ILLC16 *2 Cannot be used with SZX2-FO and has some limitations with SZX2-ILR66 or LG-R66 *3 Please contact your nearest Olympus dealer for applicable combination
*4 Cannot be attached to SDFPLAPO1.6XPF/2XPF *5 Different types may be offered in some areas including EU countries

Accessories

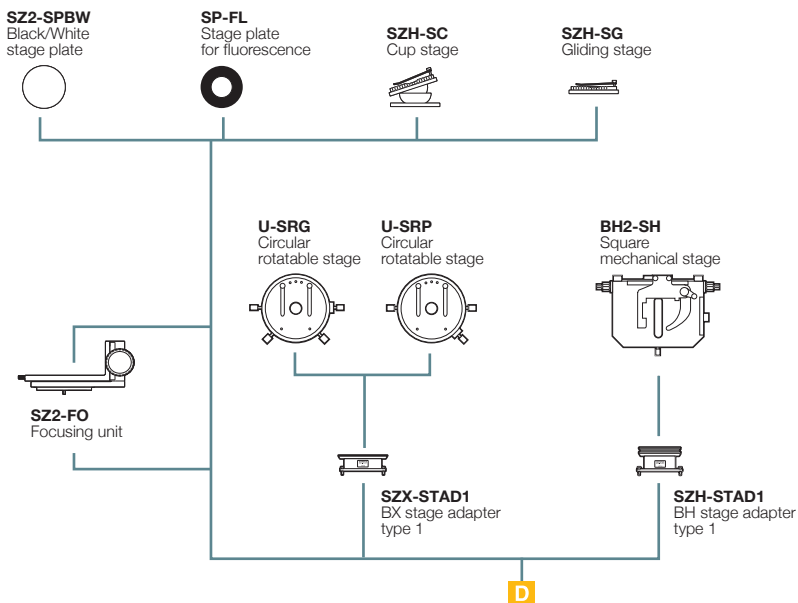

Focusing units



Illuminators

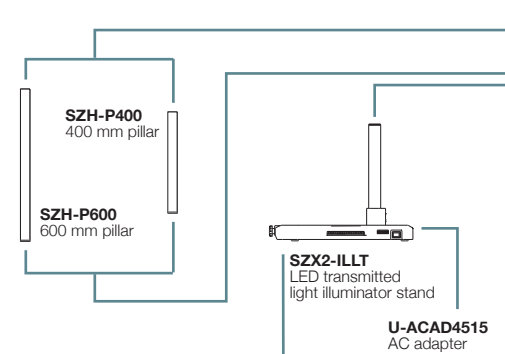

SZX10

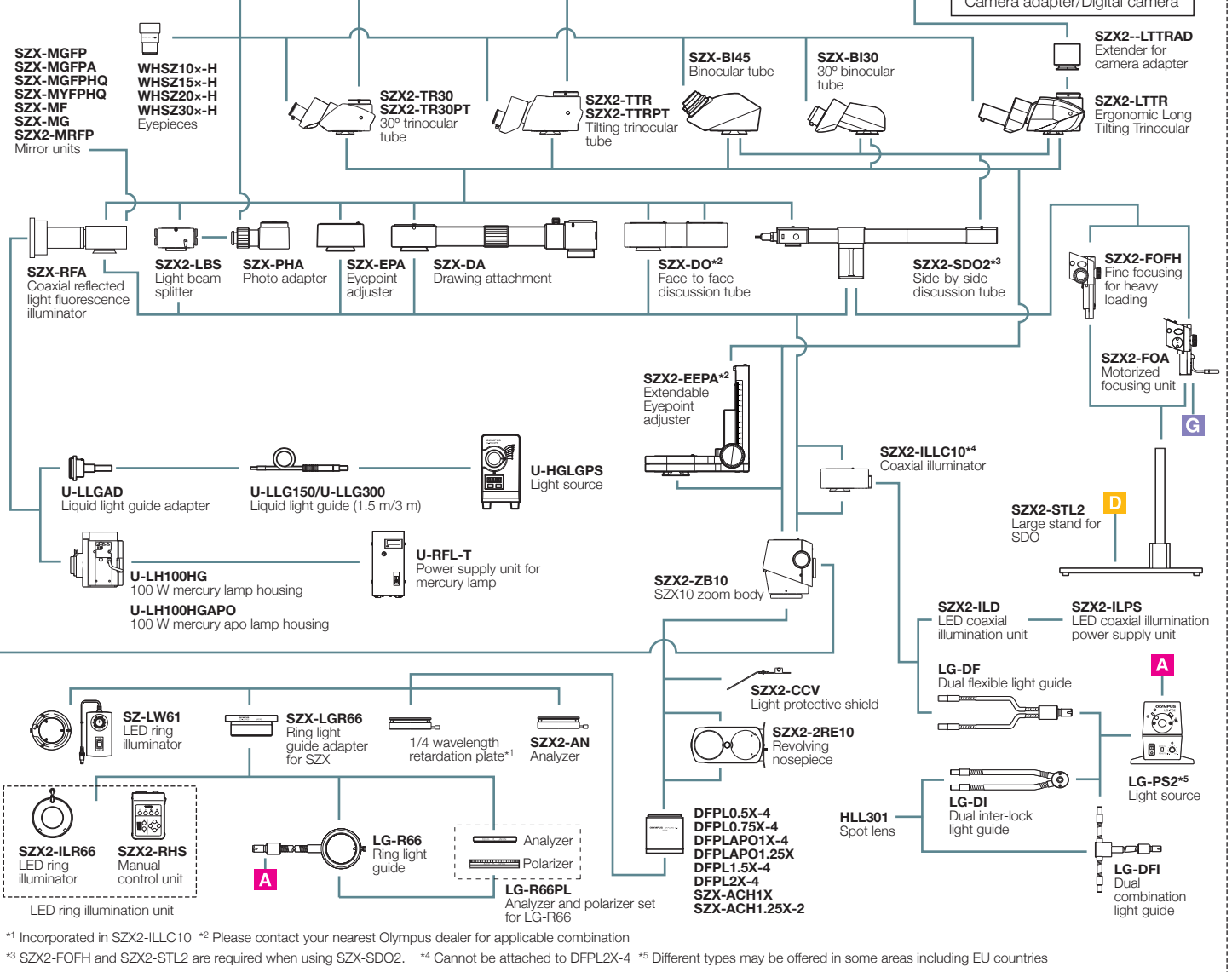

^{*1} Incorporated in SZX2-ILLC10 ^{*2} Please contact your nearest Olympus dealer for applicable combination

^{*3} SZX2-FOFH and SZX2-STL2 are required when using SZX-SDO2. ^{*4} Cannot be attached to DFPL2X-4 ^{*5} Different types may be offered in some areas including EU countries

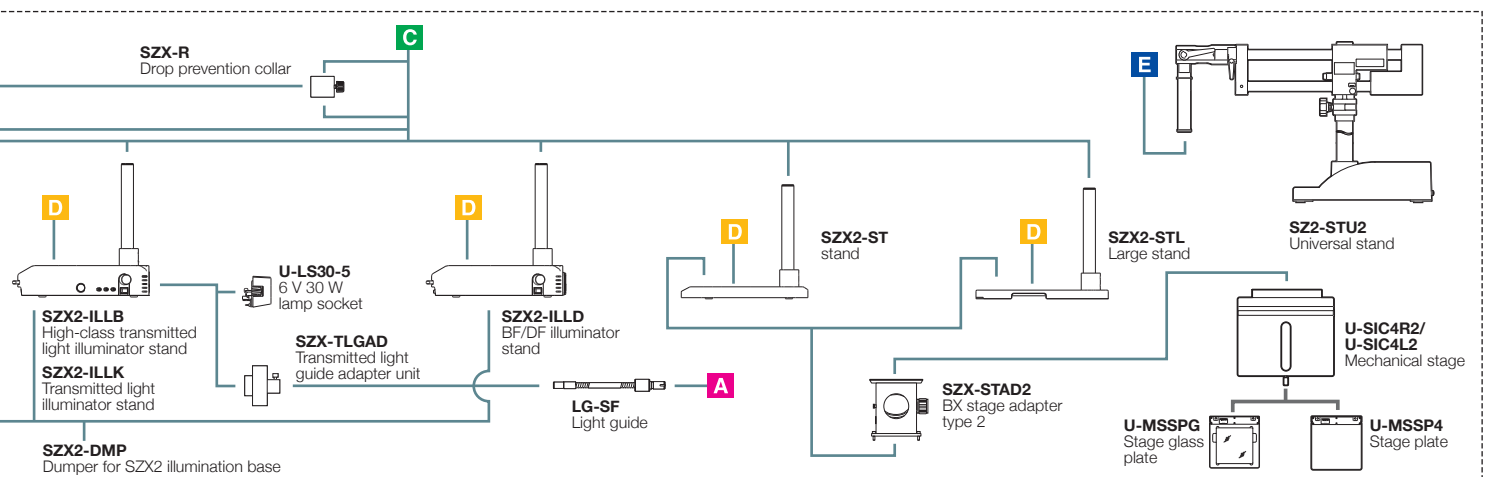
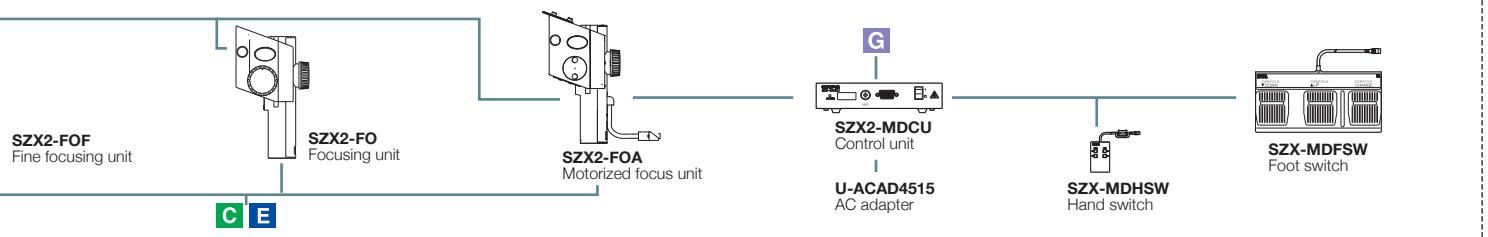

DSX110 Digital Microscope, Free-angle Wide-zoom Scope



- A wide optical zoom ratio 16:1* makes seamless observation.
- Superb operating simplicity: focusing, zoom, stage movement and microscopic controls including illumination select via touch screen computer.
- Variable-angle scope: 3D images, panoramic images, simple measurement and report generation are easily performed.
- Best Image Function ensures the best possible image from a list of images.

* Digital zoom till 30X available

- OLYMPUS CORPORATION is ISO14001 certified.
- OLYMPUS CORPORATION is ISO9001 certified.
- Illumination devices for microscope have suggested lifetimes. Periodic inspections are required. Please visit our web site for details.

- All company and product names are registered trademarks and/or trademarks of their respective owners.
- Images on the PC monitors are simulated.
- Specifications and appearances are subject to change without any notice or obligation on the part of the manufacturer.

www.olympus-ims.com

OLYMPUS[®]

For enquiries - contact
www.olympus-ims.com/contact-us

OLYMPUS CORPORATION
Shinjuku Monolith, 2-3-1 Nishi-Shinjuku, Shinjuku-ku, Tokyo 163-0914, Japan
OLYMPUS EUROPA SE & CO. KG
Wendenstrasse 14-18, 20097 Hamburg, Germany
OLYMPUS SCIENTIFIC SOLUTIONS AMERICAS CORP.
48 Woerd Avenue, Waltham, MA 02453, U.S.A.
OLYMPUS MEDICAL SYSTEMS INDIA PRIVATE LIMITED.
102-B, First Floor, Time Tower, M.G. Road, Gurgaon 122001, Haryana, INDIA

OLYMPUS (CHINA) CO., LTD.
10F, K. Wah Centre, 1010 Hual Hai Road (M), Xuhui District, Shanghai, 200031 P.R.C.
OLYMPUS KOREA CO., LTD.
8F Olympus Tower, 446 Bongeunsa-ro, Gangnam-gu, Seoul, 06153 Korea
OLYMPUS AUSTRALIA PTY. LTD.
3 Acacia Place, Notting Hill VIC 3168, Australia
OLYMPUS SINGAPORE PTE LTD.
491B River Valley Road, #12-01/04 Valley Point Office Tower, Singapore 248373

M1702E-012016