

Smart Features, Next-Generation Image Quality

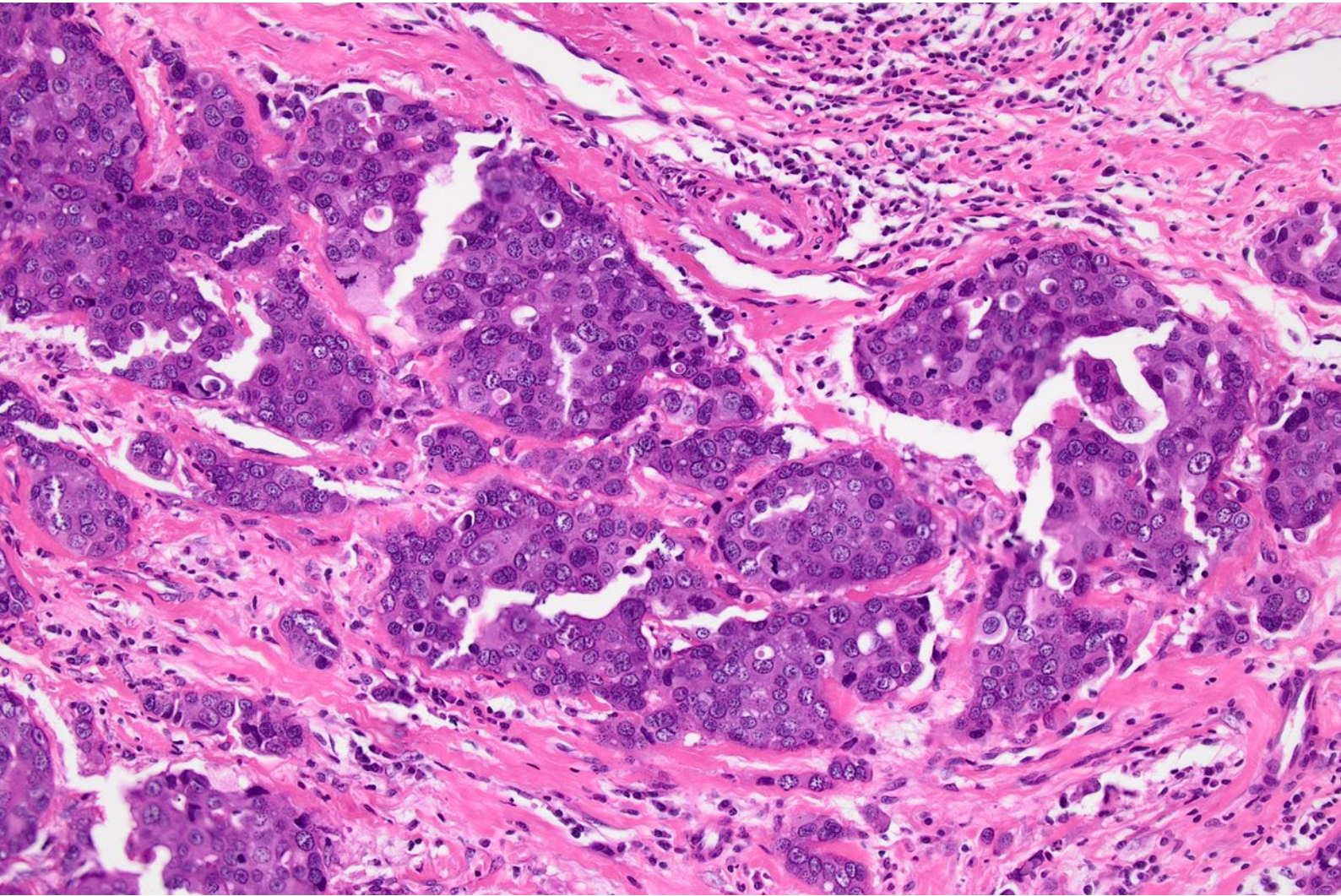

Advance Your Imaging

Designed for routine life science and clinical research microscopy imaging, the DP23 microscope digital camera's combination of smart features and reliable color reproduction provide high-quality images in a camera that's easy to use.



High Image Resolution and Color Fidelity Make Your Research More Efficient

The Right Balance of Resolution and Speed

The DP23 camera's 6.4-megapixel high resolution at 30 frames per second (fps) enables you to quickly capture images with the level of detail you need for most life science imaging applications. And to ease collaboration, you can share images using cellSens imaging software with the NetCam solution or using the optional standalone controller's image sharing function.

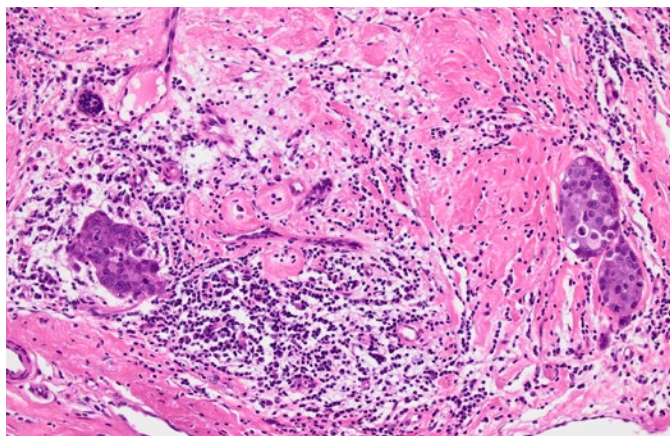

Human breast/ HE/10x

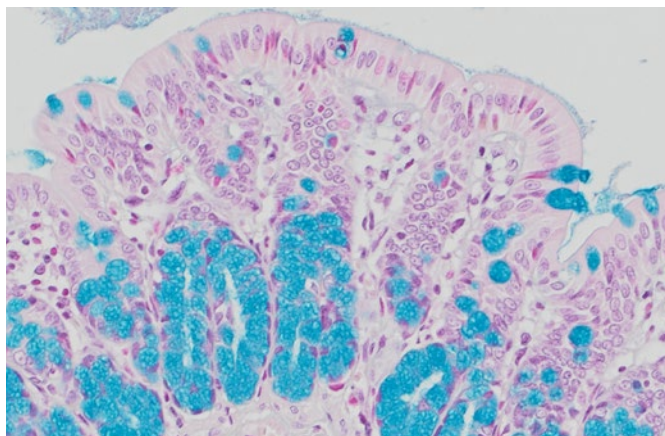

Rat colon/ AB/ 10x

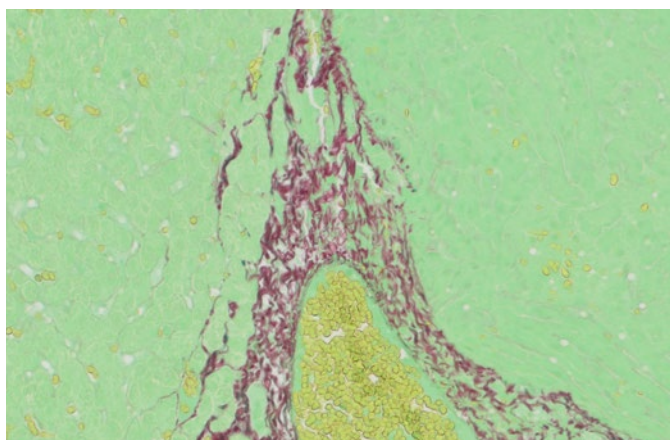

Liver/ Fast green/ 20x

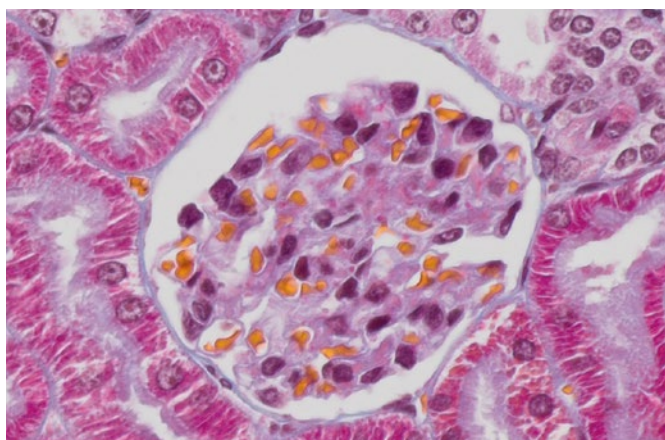

Rat kidney/ MT/ UPLXAPO20X

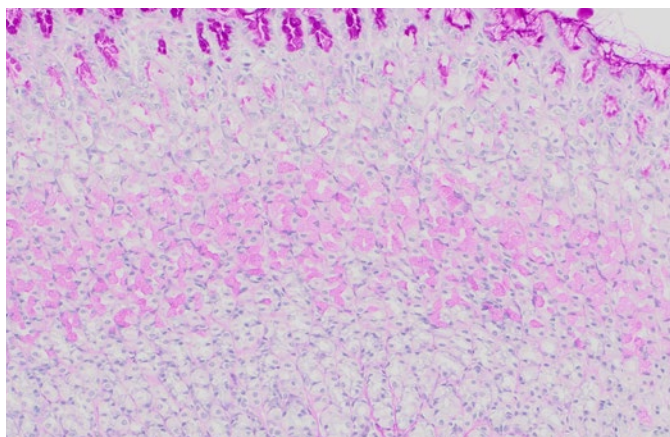

Rat duodenum/ PAS / 10x



Dog heart/ Schmorl/ 20x

Colors You Can Trust

Like all cameras in the DP series—which are famous for their color reproduction for clinical research and life science samples—the DP23 realizes reliable color on your monitor. Dedicated ICC profiles show your samples in their natural colors, so the dyes you use look the way you expect them to. With Olympus' TruColor LED light source for the BX53 microscope, the DP23 camera is part of a complete system that provides high color reproduction from the light source to the camera.

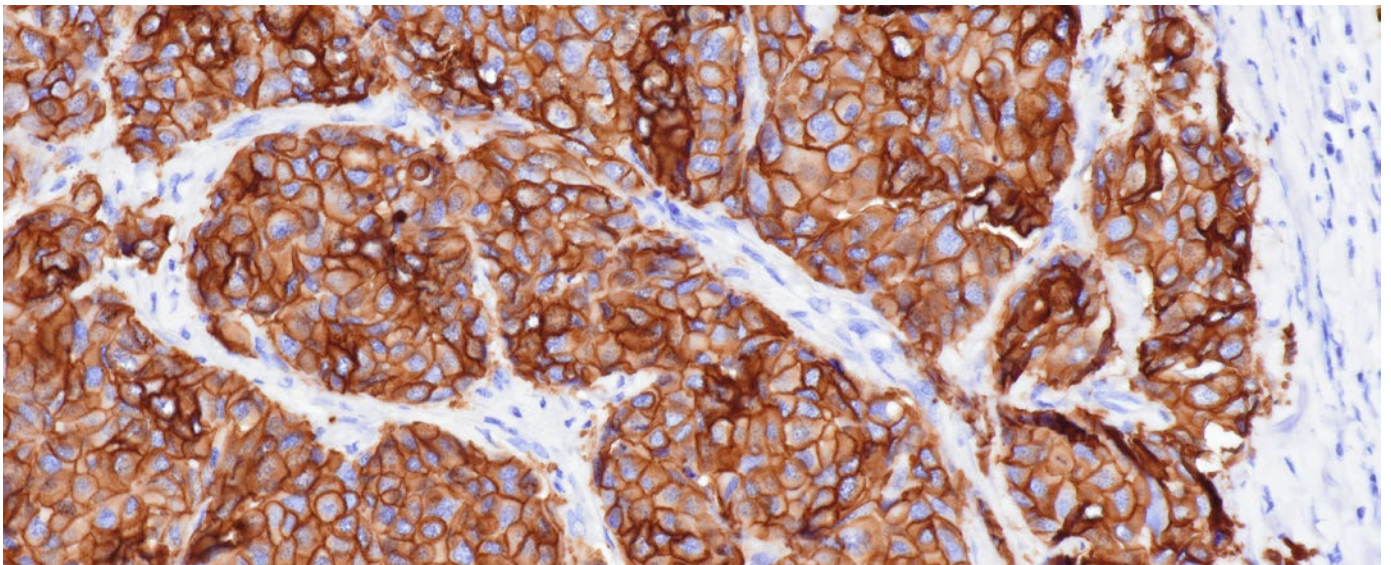

See More at a Glance

Within the incredibly large field of view (FOV), you not only see more of your sample, but the images are sharp, flat, and in focus from the center to the periphery, enabling efficient imaging and analysis. With Olympus' renowned optics—including X Line high-performance objectives and a 0.35X camera adaptor—you can maximize the advantage of a wide field of view up to FN25.

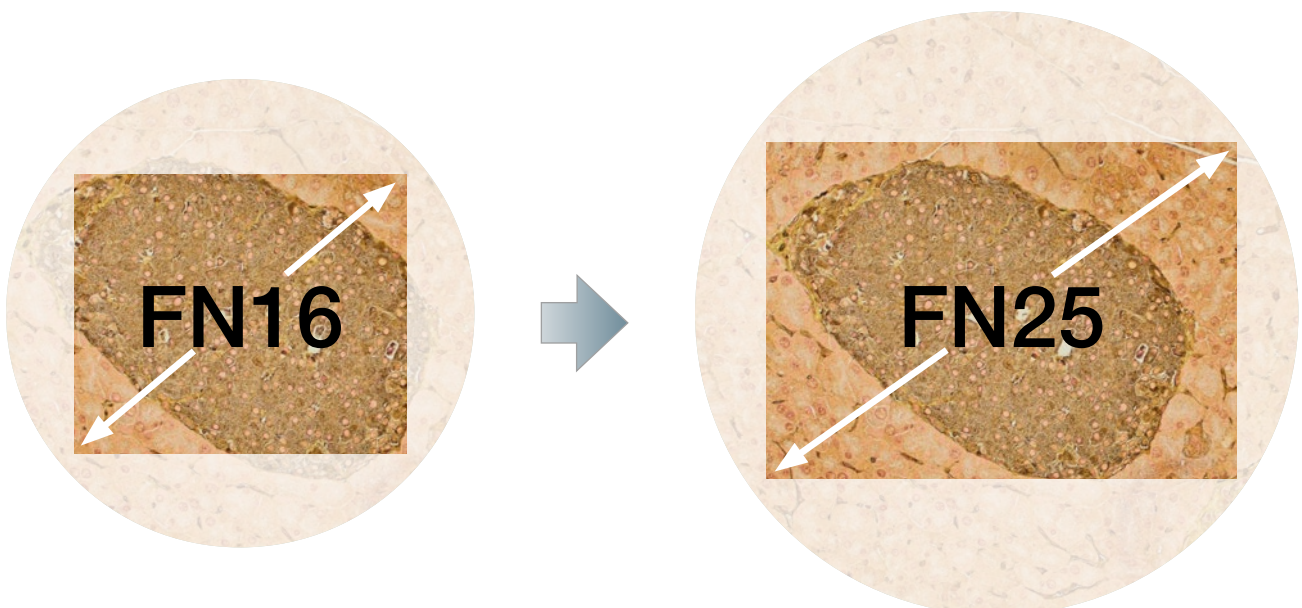

*Your microscope system must be compatible with an FN25 FOV.

Image Capture Made Easy with Smart Features

Smart Imaging Technology

Olympus Smart Image Averaging (OSIA)* suppresses noise while maintaining fast frame rates and eliminating artifacts. OSIA automatically maximizes the camera's image quality with no adjustments.

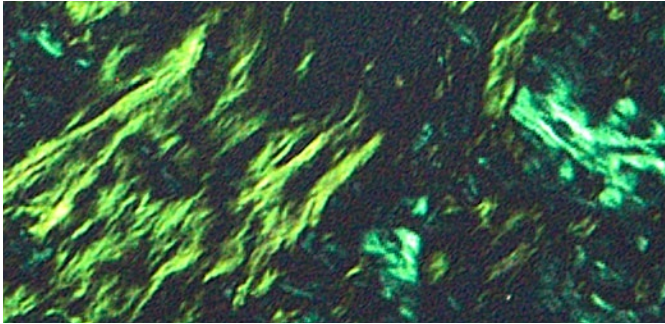

Without OSIA

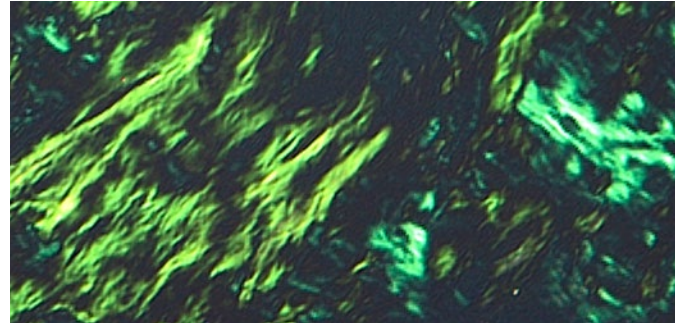

With OSIA

Capture Clear Images from Dim Samples

During polarization and fluorescence microscopy, the High Contrast mode enables easier image acquisition with a high signal-to-noise ratio so that you can capture high-quality images from dim samples. The feature automatically adjusts the exposure time and the proper contrast setting.

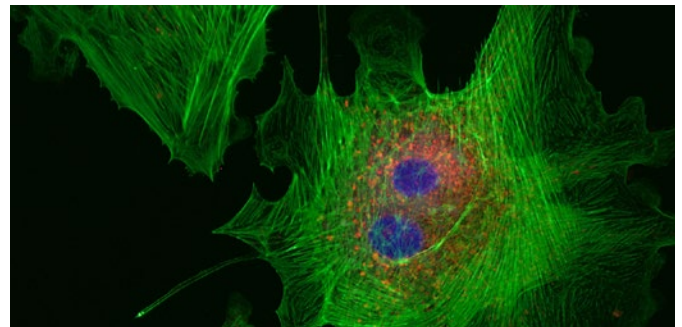

Smooth Live Images

The Fast Live function takes advantage of the camera's ability to capture full HD images at 60 fps to provide a consistently high displayed frame rate during long-exposure imaging. The result is a smooth image when scanning samples, even under low light conditions.

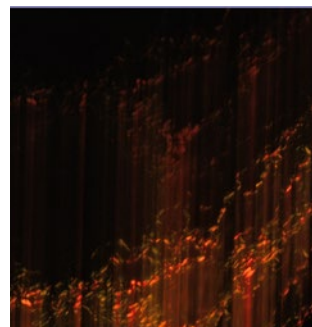

Fast Live off

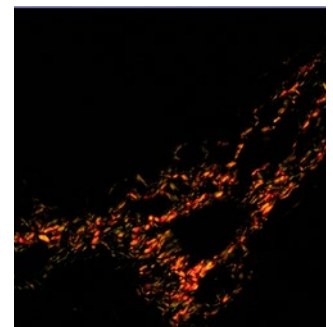

Fast Live on

Easy Precision Focusing

If you're observing thick specimens, the Focus Peaking function* helps you identify which sample regions are currently in focus. The software indicates in-focus areas in color and the out-of-focus areas in grayscale in an overlay on a live image.

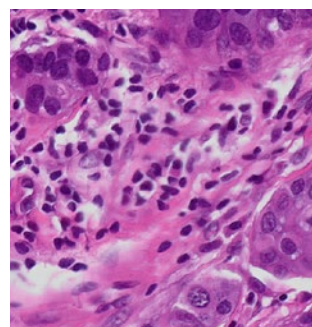

Without Focus Peaking

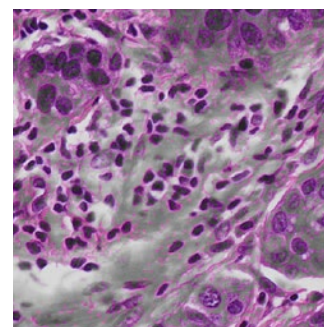

With Focus Peaking

*Available in cellSens imaging software.

Simple to Set Up and Use

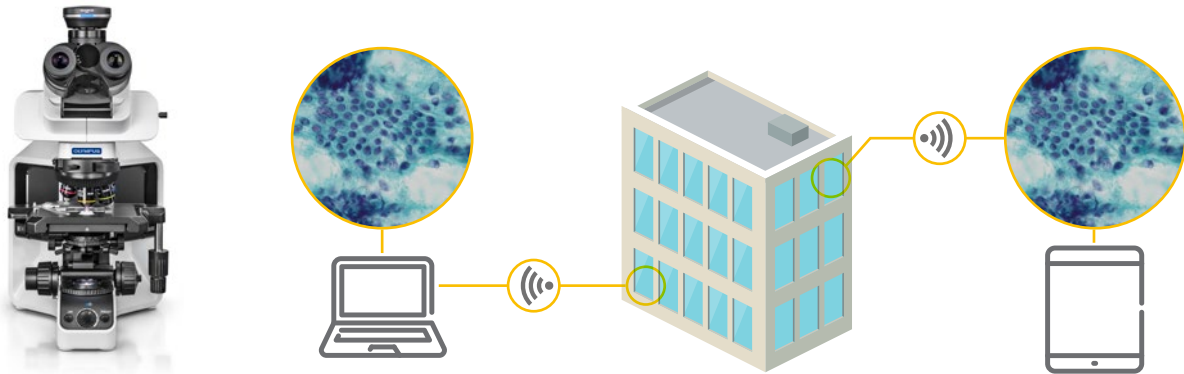

Fast, Efficient Remote Collaboration

All your critical data—images, annotations, and live measurements—can be displayed and shared together locally or remotely using cellSens software with the NetCam solution or the standalone camera control module's remote image sharing feature.*¹ This provides a simpler way to discuss and share smooth 30 fps, full HD, live images with colleagues rather than relying on email attachments. And thanks to support for network security protocols such as NIST and GDPR along with antivirus support, you can share your data safely.*¹

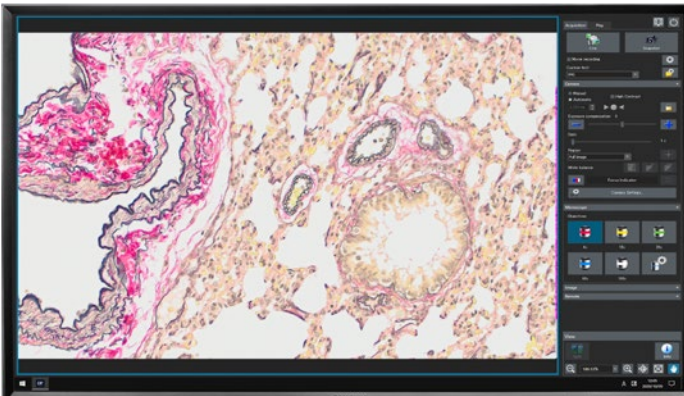

One-Click Image Acquisition

The camera's thoughtfully designed interface makes image acquisition simple. In most cases, you can acquire images with just a single click for an efficient workflow. Whether you choose the advanced functionality of Olympus cellSens software or the targeted functionality of the stand-alone DP23-AOU (Advanced Operation Unit) camera module, both have a simple user interface that makes your workflow faster everyday.



Save Valuable Work Space with a PC-Less Configuration

You can attach the camera's standalone module to the back of your monitor to free up valuable desk space—no separate PC is required.

Plug and Play Simplicity

Just plug the camera cord into your computer's USB 3.1 port*², and it's ready to use. No separate AC adaptor is required.

*1 Remote image sharing and antivirus software are optional.

*2 USB 3.1 Gen 1 is compatible with USB 3.0.

DP23 Specifications

DP23-CU

| | | |
|----------------|---|---|
| Type | 6.4-megapixel color camera | |
| Imaging sensor | Sensor type | 1/1.8-inch color CMOS |
| | Shutter type | Rolling Shutter |
| | Pixel size | 2.4 μm \times 2.4 μm |
| | Dynamic range | 10 bit |
| Sensitivity | Gain | 1–24 |
| Mount | Camera adaptor | C-mount |
| Exposure time | Manual exposure: 13 μs –15 s | |
| | Auto exposure: 13 μs –15 s | |
| Camera I/F | USB 3.1 Type-C ^{*1} (cable length: 2.9 m (9.5 ft)) | |
| Dimensions | Camera head (W \times D \times H) | 76.7 mm \times 70.1 mm \times 37.3 mm (3 in. \times 2.8 in. \times 1.5 in.) |
| | Control unit (W \times D \times H) | 180 mm \times 180 mm \times 53 mm (7 in. \times 7 in. \times 2 in.) |

| | PC connection ^{*2} | Standalone |
|---|--|---|
| Image size (W \times H) | 3088 \times 2076 (full resolution) | 3088 \times 2076 (full resolution) |
| | 2072 \times 2072 (square) | 2072 \times 2072 (square) |
| | 1544 \times 1038 (sub-sampling 2 \times 2—high speed) | 1544 \times 1038 (sub-sampling 2 \times 2—high speed) |
| | 1544 \times 1038 (binning 2 \times 2—high sensitivity) | 1544 \times 1038 (binning 2 \times 2—high sensitivity) |
| Live image display (frame rate) ^{*3} | 1920 \times 1080 (full HD) | 1920 \times 1080 (full HD) |
| | 45 fps (full resolution) | 30 fps (full resolution) |
| | 58 fps (square) | 43 fps (square) |
| | 59 fps (sub-sampling 2 \times 2—high speed) | 59 fps (sub-sampling 2 \times 2—high speed) |
| | 59 fps (binning 2 \times 2) | 59 fps (binning 2 \times 2) |
| Compatible image display | 60 fps (full HD) | 60 fps (full HD) |
| | Depends on the PC's specifications. | 3840 \times 2160 4K UHD TV |
| | | 2560 \times 1440 WQHD |
| | | 1920 \times 1200 WUXGA |
| | | 1920 \times 1080 FHD |
| | | 1680 \times 1050 WSXGA+ |
| | | 1440 \times 900 WXGA+ |
| | | 1366 \times 768 FWXGA |
| | | 1280 \times 854 HDTV (720 p) |
| 1600 \times 1200 UXGA | | |
| 1280 \times 1024 SXGA | | |
| Storage media | Depends on the PC's specifications. | Integrated device for image storage (SSD: 60 GB) |
| | | External USB storage device PC connected to network |
| Controller interface | USB3.1 Gen1 | Display output: 2 \times HDMI |
| | | Peripheral I/F: 4 \times USB3.1 Gen1 |
| | | Wired LAN: 2 \times LAN (1000BASE-T/100BASE-TX/10BASE-T) |
| | | Serial port: RS-232C |
| Scale display | Scale bar Info stamp Zooming magnification | Audio: Mic. input (monaural), phone jack |
| | | Supported |
| | | Document name, total magnification, objective magnification, zoom magnification |
| Measuring function | According to cellSens ^{*4} specifications | 10% to 1600% |
| | | Measurement function count, distance between 2 points, polyline, 3-point circle, rectangle, 3-point angle, 4-point angle, perpendicular, area and perimeter of polygon, distance between 2 centers, ruler |

| Remote function | PC connection | Standalone |
|-------------------------------|--|--|
| Optional license | cellSens Netcam (remote function) ^{*4,5} | Network solution (remote function) ^{*6} Antivirus software (white list type) |
| Web browser (client computer) | Microsoft Edge (chromium) Google Chrome Safari | Microsoft Edge (chromium) Google Chrome Safari |
| Customer PC OS requirements | Windows 10 Pro 64-bit, Android 9.0 or higher, iOS 12.0 or higher. Please contact your local Olympus representative for details about the requirements. | Windows 10 Pro 64-bit, Android 9.0 or higher, iOS 12.0 or higher |

*1 USB 3.1 Gen 1 is compatible with USB 3.0

*2 Refer to the PC requirements of cellSens software.

*3 Frame rate may decrease, depending on the condition of your PC and/or software.

*4 cellSens software is not for clinical diagnostic use.

*5 cellSens v. 3.1.1 or later.

*6 Network must be within an Intranet. For a wireless connection, a USB wireless LAN adaptor is also required.

DP23 Standalone Configuration System Diagram

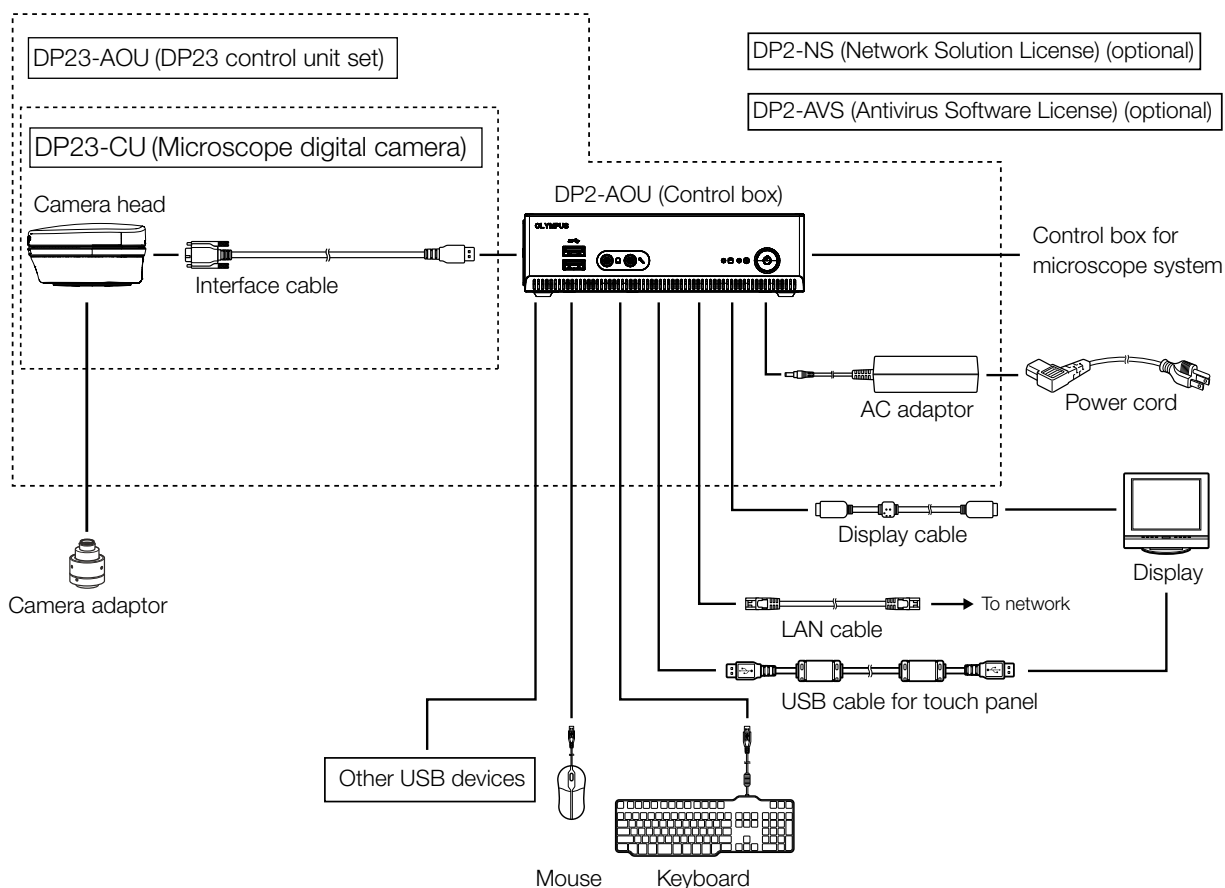

DP23 PC Configuration System Diagram

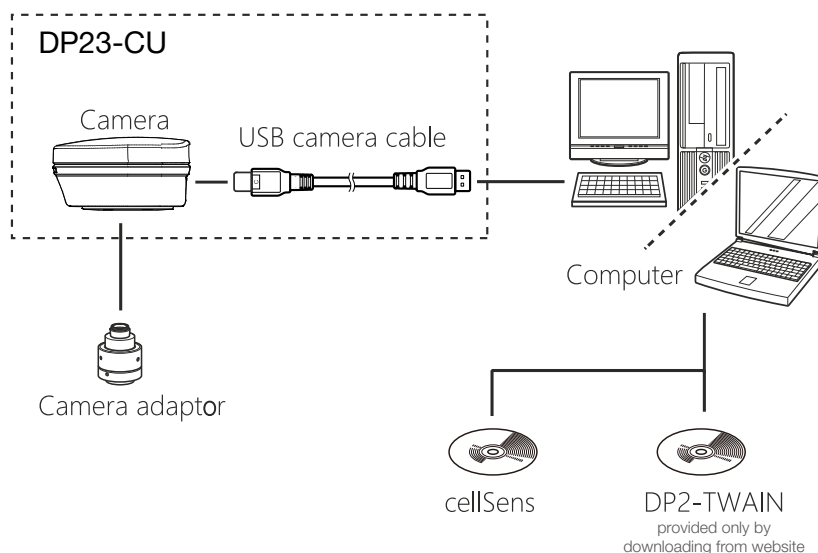

- OLYMPUS CORPORATION is ISO14001 certified.
- OLYMPUS CORPORATION is ISO9001 certified.



- Microsoft and Windows are registered trademarks of Microsoft Corporation in U.S. The terms HDMI and HDMI High-Definition Multimedia Interface, and the HDMI Logo are trademarks or registered trademarks of HDMI Licensing Administrator, Inc. in the United States and other countries. The SuperSpeed USB 5Gbps Trident Logo is a registered trademark of USB Implementers Forum, Inc. All brand names or product names described in this instruction manual are trademarks or registered trademarks of relevant owners.
- All company and product names are registered trademarks and/or trademarks of their respective owners. Olympus, the Olympus logo, cellSens, and OLYMPUS Stream are trademarks of Olympus Corporation or its subsidiaries.
- Specifications and appearances are subject to change without any notice or obligation on the part of the manufacturer.

www.olympus-lifescience.com

OLYMPUS

OLYMPUS CORPORATION
Shinjuku Monolith, 2-3-1 Nishi-Shinjuku, Shinjuku-ku, Tokyo 163-0914, Japan

Printed in Japan N8602100-012021