

Get More Out of Your Digital Microscope



Intelligent Innovation

"Fast failure analysis with guaranteed accuracy and repeatability"



Macro to Micro Versatility

- ▶ Large selection of lenses to find the best magnification, resolution, and working distance for your sample
- ▶ Coded free-angle observation system



3 - 8



Multiple Observations with a Single Click

- ▶ Change lenses and observation method quickly by pushing a button
- ▶ All observation methods are available at all magnifications



9 - 14



Be Confident in Your Results with Guaranteed Accuracy and Precision

- ▶ Accurate measurements with a telecentric optical system
- ▶ Both accuracy and repeatability are guaranteed at all magnifications



15 - 18



Macro to Micro Versatility

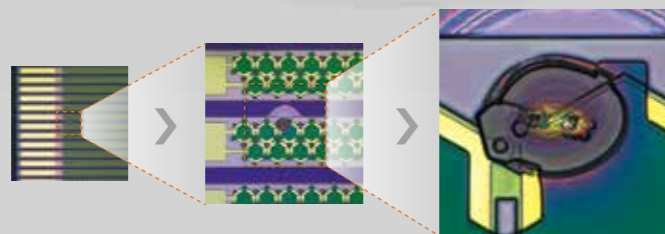

The microscope's 20X to 7000X magnification range enables you to conduct high-level, low-magnification overview observations and seamlessly zoom down to the micron level for detailed analysis. The depth of field and a long working distance give you the flexibility to inspect larger samples, while the free-angle observation system enables you to image your sample from many directions.

The Tool to Solve Your Challenges

Rough Inspection and Micron-Level Analysis with One System

In the past, both high-magnification and low-magnification microscopes were needed to complete an inspection. Switching your samples between microscopes took time and required many setting adjustments.



- Better objectives deliver better resolution
- Long working distance
- Deep depth of focus
- Quick and easy lens replacement

DSX1000 Complete your inspection with one easy-to-use system.

High-Resolution Images at High Magnification

When inspecting uneven samples, it is important to maintain a safe distance between the lens and sample to keep from damaging it. To see details, you need to increase the magnification, but this typically results in worse resolution.

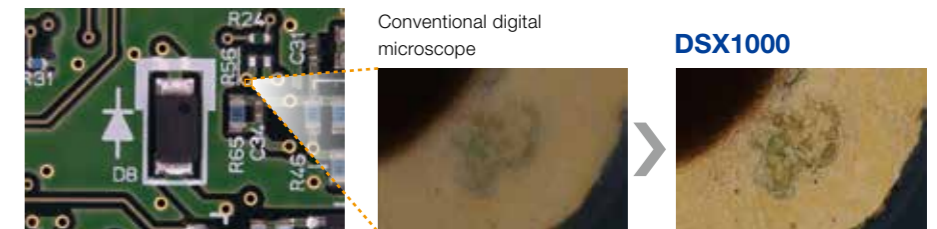

DSX1000 High-quality images at high magnification with advanced optics.

Minimize the Chance of Crashing into Your Sample

If the distance between your sample and the lens is too small, the objective can crash into the sample during analysis, potentially damaging it.



DSX1000 Observe uneven samples without bumping into them.

Choose the Best Lens for Your Analysis

Our lineup of 17 objective lenses, including super long working distance and high numerical aperture options, provides the flexibility to obtain a wide range of images.



For more information on our lenses, see pages 27 and 28.

See the Whole Picture: 20X to 7000X Magnification Range

Seamlessly change magnification from high-level analysis to detailed observation by pushing a button.

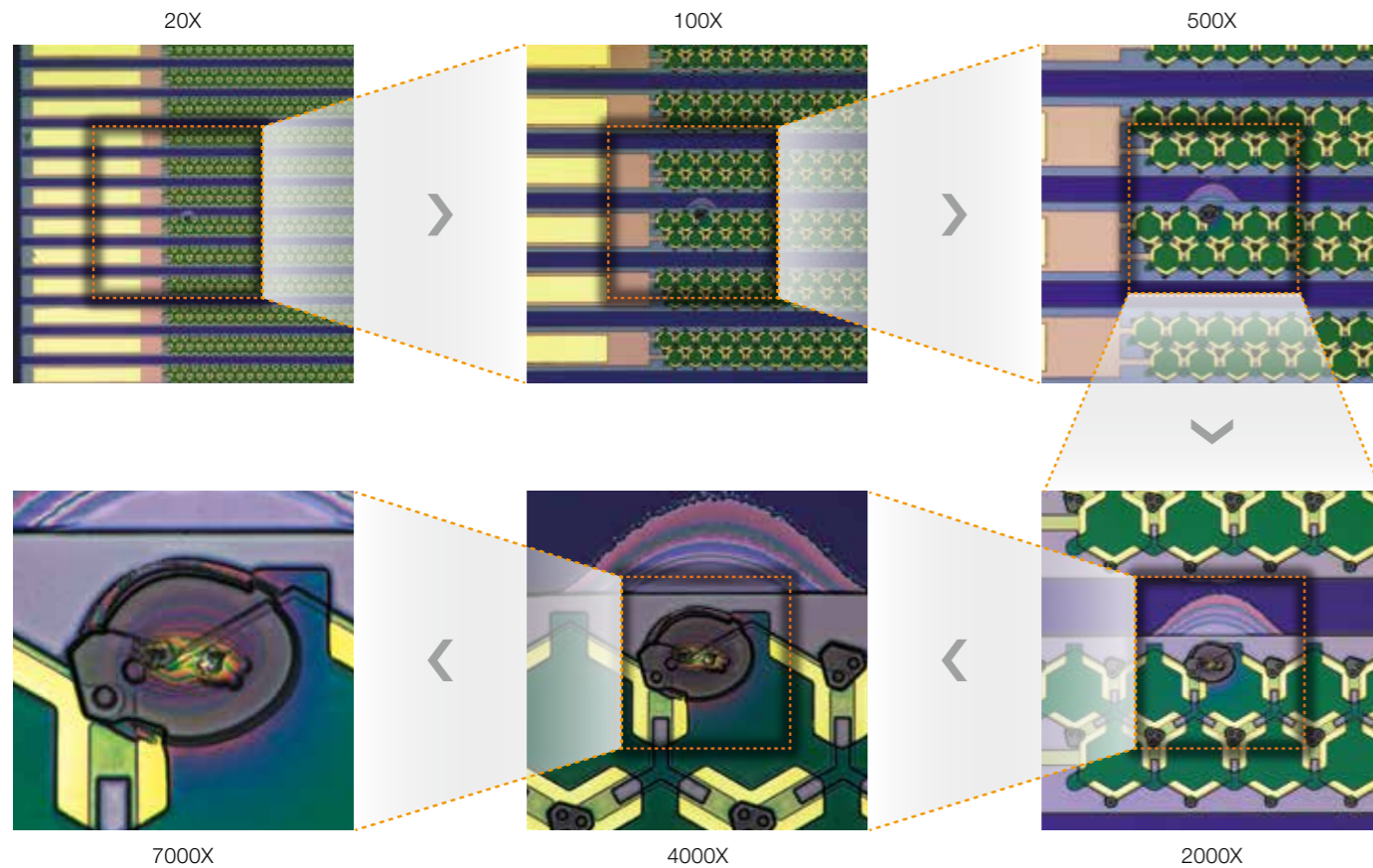

Minimize the Chance of Crashing into Your Sample

The DSX1000 system offers a wide depth of field and a long working distance, so you can observe uneven samples with less chance of causing damage.



SXLOB series

High Resolution and a Long Working Distance in One Objective

Objectives combining high resolution and long working distance enable you to analyze large, uneven samples, such as automobile and machines parts, that were difficult to inspect in the past using an optical microscope.



XLOB series

Exceptional Resolution with a 0.95 Numerical Aperture

The DSX1000 digital microscope enjoys the full benefits of optical microscope lenses. Their chromatic aberration correction enables you to see the fine details in your sample.



UIS2 series

See Your Sample from Many Angles

Oblique observation ($\pm 90^\circ$)

The eucentric optical design maintains a good visual field when tilted or when the stage is rotated, enabling you to observe your sample from many angles. This flexibility frees you from only having the option to observe your samples directly from above, helping you spot hard-to-see defects.

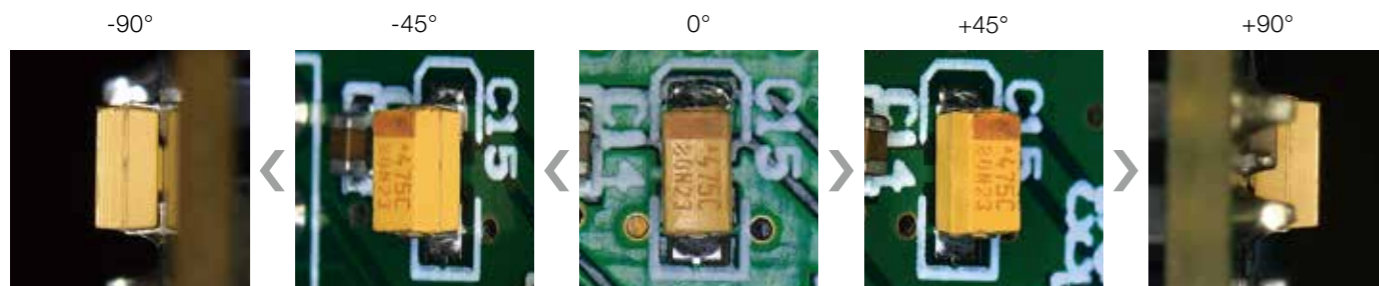

Rotational observation ($\pm 90^\circ$)

The stage rotates 90 degrees for even more flexibility in how you view your sample.

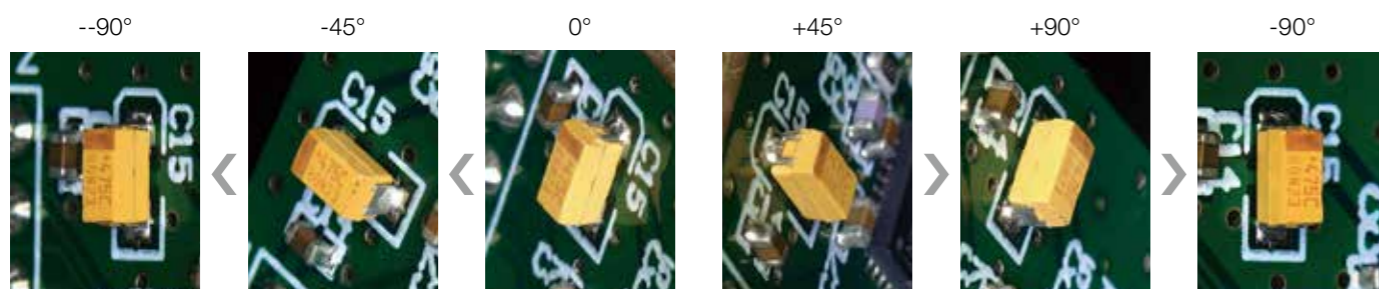
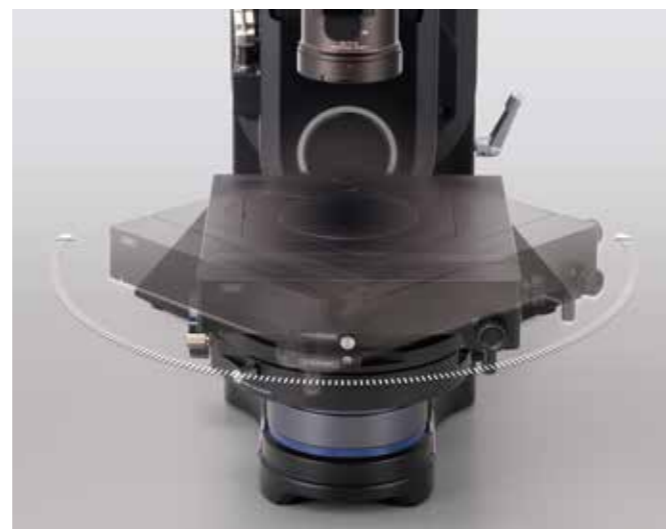

Always Know Your Angles

The system automatically tracks the inclination and angle rotation information for each image.

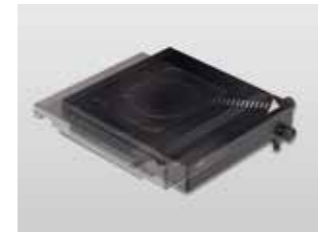

Movement of rotating stage



Inclination angle sensor



Micro map function

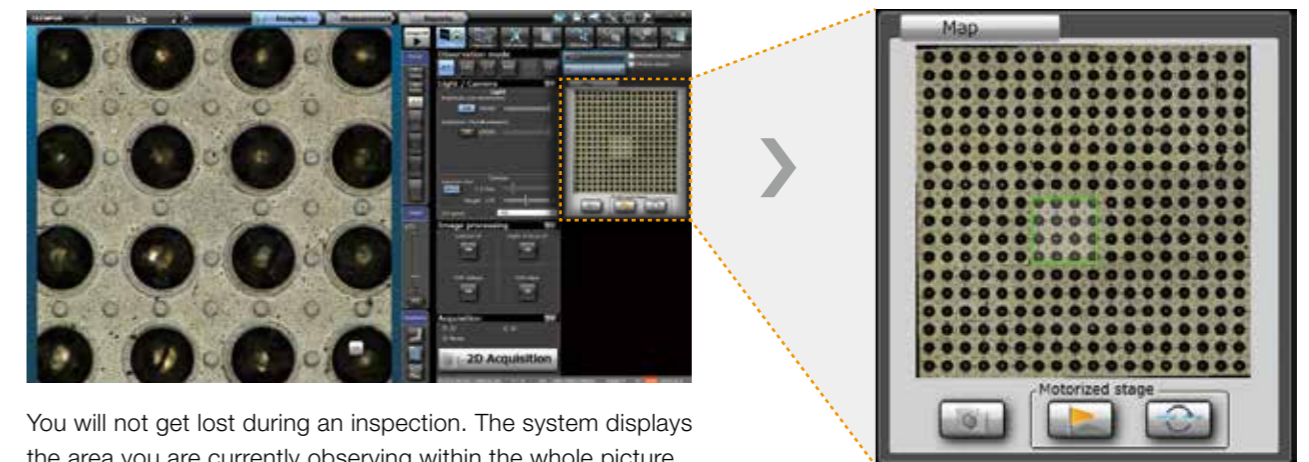

You will not get lost during an inspection. The system displays the area you are currently observing within the whole picture, even in zoom mode.

Easy-to-Use Console



XY stage and Z-drive control with joystick

Quickly move the zoom head by adjusting the fine focus knob

Multiple Observations with a Single Click

Sliding Nosepiece



Six Observation Methods



Console



The DSX1000 microscope offers flexibility to make your inspection workflow faster and easier. Changing observation is as simple as turning a dial while switching between Six different observation methods requires only the push of a button.

Instant Switching Saves Time

Conventional systems may only offer one or two observation methods, limiting what you can see in your sample. The DSX1000 microscope offers various observation methods from which you can choose the one that works best for your job.

Supported Observation Methods for Conventional Digital Microscopes

	Observation method A	Observation method B	Observation method C
Lens magnification A	Unsupported	Unsupported	Supported
Lens magnification B	Unsupported	Unsupported	Supported
Lens magnification C	Supported	Conditionally supported	Conditionally supported

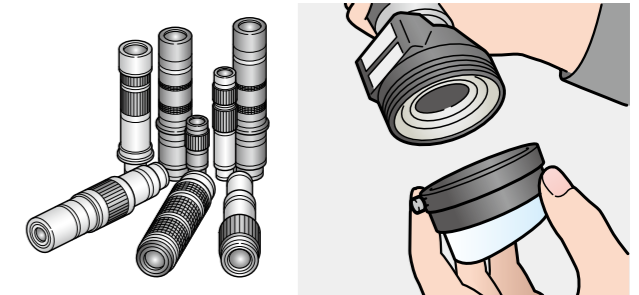

Generally, replacing lenses on an optical microscope is cumbersome and some illumination methods may not be supported.

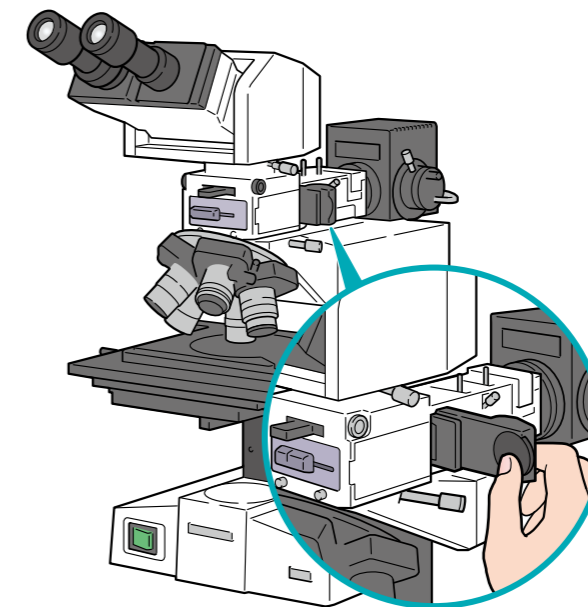

DSX1000

Choose from 6 observation methods, and switch between them with a single click.

Change Magnification Quickly and Easily

With some digital microscopes, you need to replace the object lens to adjust the magnification. This can be a slow process, potentially requiring you to remove the camera cable each time and also must be restart the software. During this process, you might lose your view on the object forcing you to spend time navigating back to the correct spot. The DSX1000 enables you to easily and quickly change magnification from the macro to the micro range, minimizing the chance of losing the target object.

Quick Magnification Change with a Sliding Nosepiece

You can attach two objective lenses to the head at the same time and quickly change the magnification just by sliding the lens.

Instantly Switch the Lens Attachment

Objective lenses can be quickly switched you to find the best magnification for your inspection. When the lens is replaced, magnification and visual field information will automatically be updated.



Fast Motorized Optical Zoom

Optically zoom in and out by turning the console dial. The optical zoom head covers wide range of magnifications with a single objective. It's fully motorized, helping you to eliminate common errors that may occur when manually setting the zoom.



A single lens supports up to 10X zoom ratio.

Change Observation and Illumination Methods by Pushing a Button

With some microscopes, illumination methods are depend on your choice of lens, and changing illumination can be time consuming. The DSX1000 system makes this process fast, simple, and easy—just push a button.

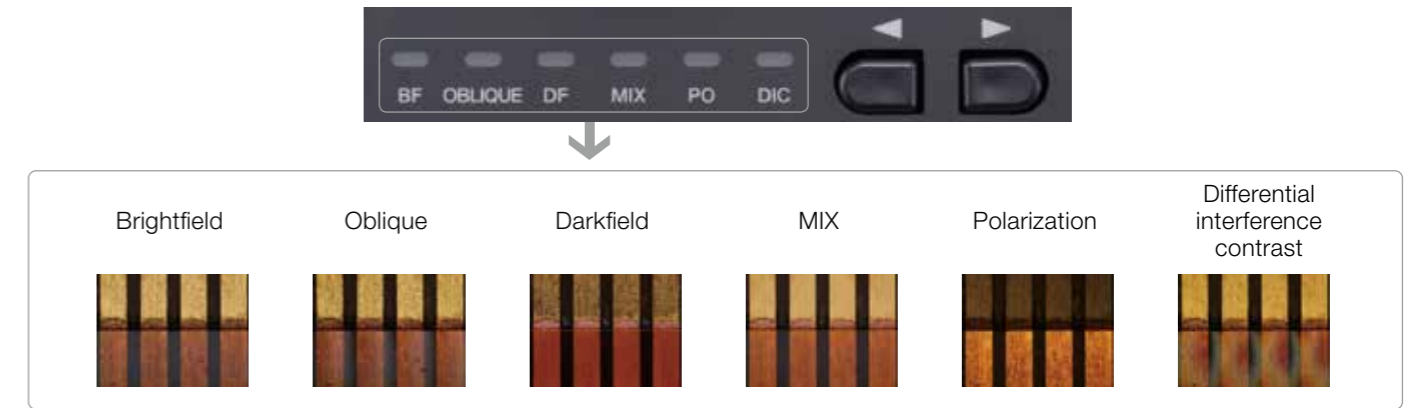

Simple Light Adjustment with Knob Dial

*Lighting is adjusted differently depending on the observation method.

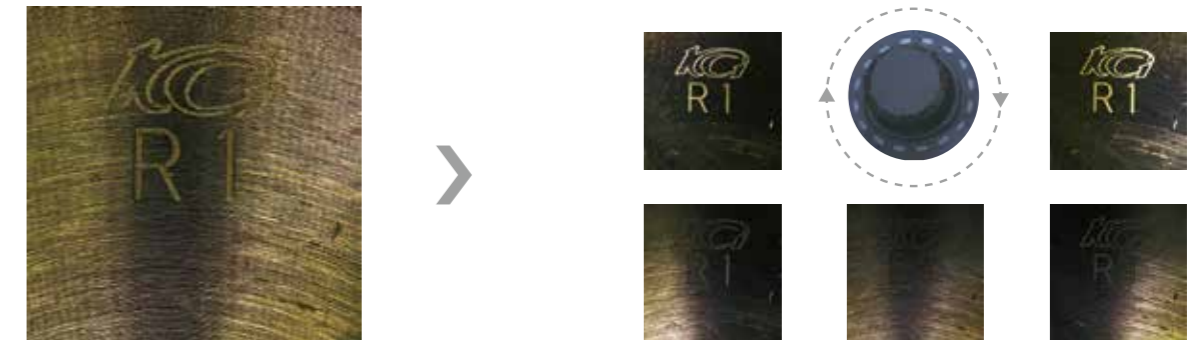

Easy-to-Use Console

The multifunction console helps you do your work quickly. For example, you can easily capture 2D or 3D images or move the XYZ stage with one click.



Integrated Observation Methods

Easily switch between brightfield (BF), oblique, darkfield (DF), MIX (BF and DF), simple polarization (PO), differential interference contrast (DIC), and contrast enhancement observation functions. This flexibility enables you to handle almost any microscope inspection task.

MIX (BF+DF)

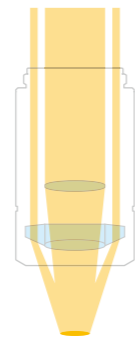

Light comes from a ring around the lens

Easily detect scratches and defects that can be hard to find with a conventional microscope by combining the detection capabilities of darkfield (DF) to the visibility of brightfield (BF).

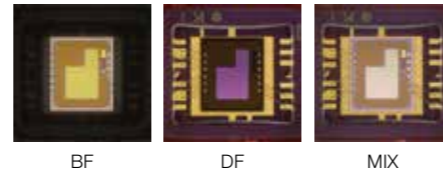

PO (Polarization)



Designed for polarizing samples

By orthogonally laying out two polarization filters, this method enables you to see the contrast and color according to your sample's polarization property.



BF (Brightfield)

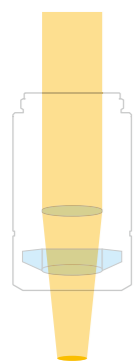

Good for flat samples

On a mirrored surface, scratches look dark against the surface, helping them stand out.



DIC (Differential Interference Contrast)

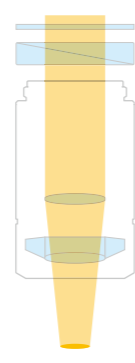

Visualize unevenness, foreign particles, scratches, and other defects at the nano level

This method enables you to visualize surface unevenness at the nano level. It's ideal for inspecting wafers, film, LCD ACF, and glass surfaces.



OBQ (Oblique)

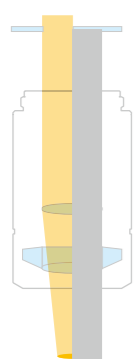

Enhance your surface's unevenness

Use this method to enhance a surface's unevenness by shining the light from only one direction. This method is ideal for uneven or corrugated samples and cutting traces.

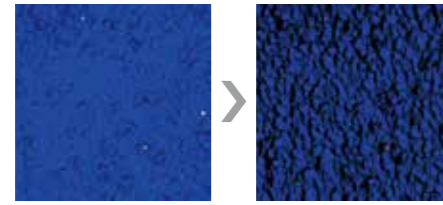

Contrast UP

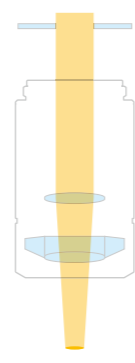

Emphasize your sample's contours

This method enhances the contrast by narrowing the optical element's aperture stop, enabling you to see sharp, vivid images. The bright parts look brighter, while the dark parts look darker.

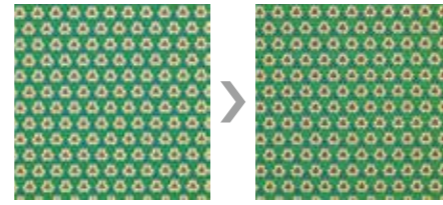

DF (Darkfield)

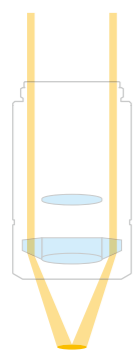

Best for detecting scratches and similar defects

Scattering or reflected light is obliquely irradiated on the sample's surface, highlighting dust, scratches, and other objects. Dust and scratches appear bright in the visual field.



Minimize Glare

The adaptor diffuses lighting to help eliminate glare and darkened slopes on a samples like a cylindrical metal surface.

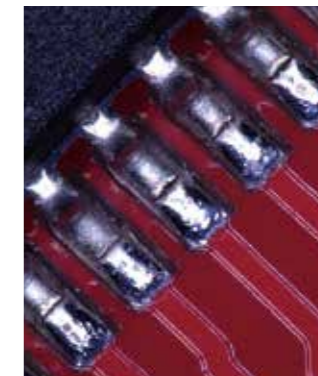

Without adaptor

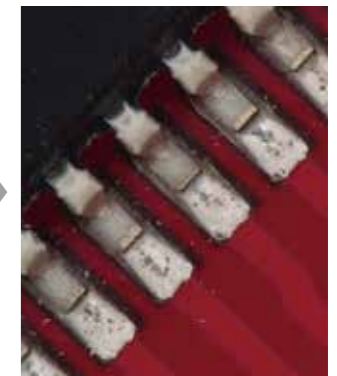

Within adaptor

Eliminate Reflections

When observing a film's surface or an object through a transparent medium, such as glass, part of the surface can look very bright. An optical polarization plate is used with the adaptor to eliminate glare.



Without adaptor

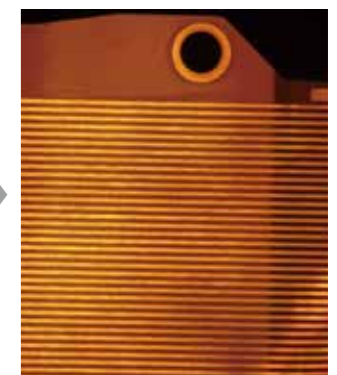

Within adaptor

High-Resolution Images at High Speed

The microscope's advanced algorithms enable you to quickly capture 3D images by pushing a button.



Fully focused image 3D image

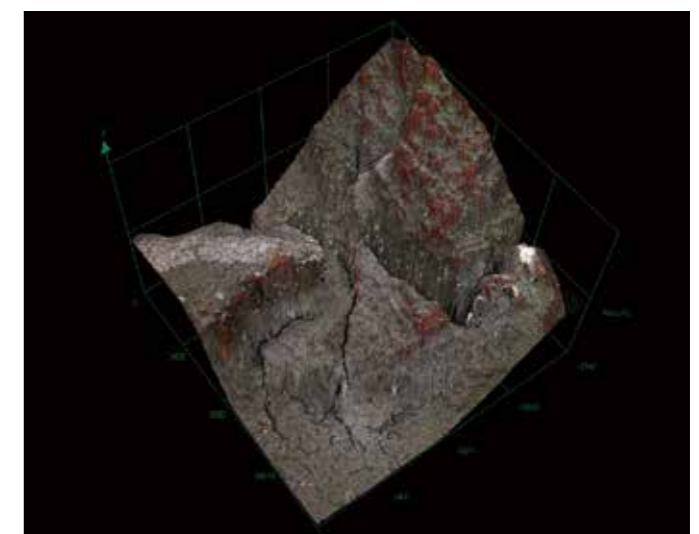

Obtaining a high visual field image by connecting images

Panoramic Images with Automatic Stitching

Capture 3D images over a wide area in panorama view. Stitch together a series of in-focus images to see your sample beyond the microscope's field of view.



Panoramic image

Be Confident in Your Results with Guaranteed* Accuracy and Precision



The microscope's telecentric optical system enables you to obtain very precise measurements while the guaranteed accuracy and precision bring confident in your results.

*To guarantee XY accuracy, calibration work must be undertaken by an Olympus service technician

Guaranteed Measurement Precision

Be Confident in Your Measurements

The precision of many general digital microscopes and optical microscopes is not guaranteed.

Conventional manual measurement

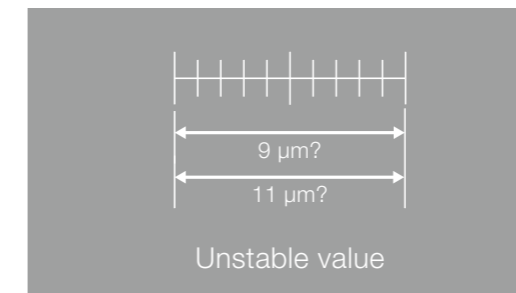

DSX1000 with measurement accuracy

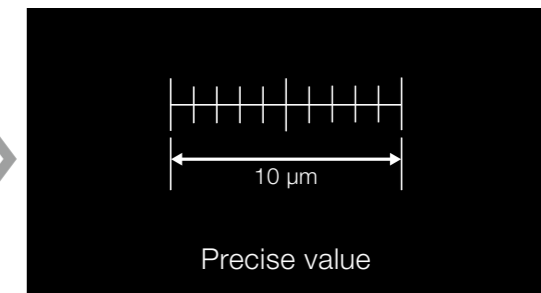

DSX1000

You can be confident in your measurement results with the guaranteed measurement precision.

On-Site Calibration

Even if the measurement precision of your microscope was guaranteed at the time of factory shipment, those results can be changed once installed.

Conventionally there is no calibration certificate



DSX1000 with calibration certificate



DSX1000

Reliable measurement with on-site calibration.

High-Precision Measurement

When imaging tall samples with conventional microscope, you may suffer from a convergence effect where the size of the object can look different depending on the point of focus. This effect makes it difficult to take accurate measurements. The DSX1000 system's telecentric optics eliminate this effect to achieve better measurement accuracy. When you need high-precision measurement, the DSX1000 is your choice.

Conventional digital microscope
(non-telecentric optical system)

DSX1000
(telecentric optical system)

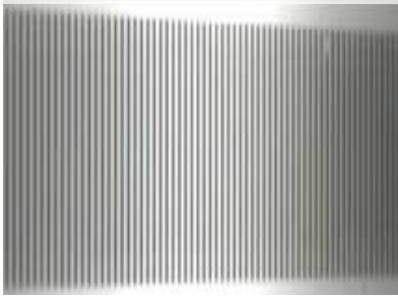

The size is different between the right and left edges in one visual field.

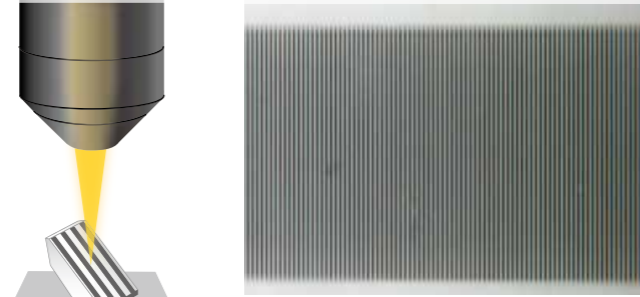

The size is the same between the right and left edges in one visual field.

Guaranteed Accuracy and Repeatability

Measurement accuracy and repeatability are guaranteed at all magnifications, so you can be confident with your measurement results.

Measurement object: 1.00 mm standard scale

Measurement count	Measurement result
1	1.0 mm
2	1.02 mm
3	0.99 mm
4	1.01 mm
5	1.0 mm
6	1.0 mm
7	0.99 mm
Measurement count	Average value
7	1.00 mm

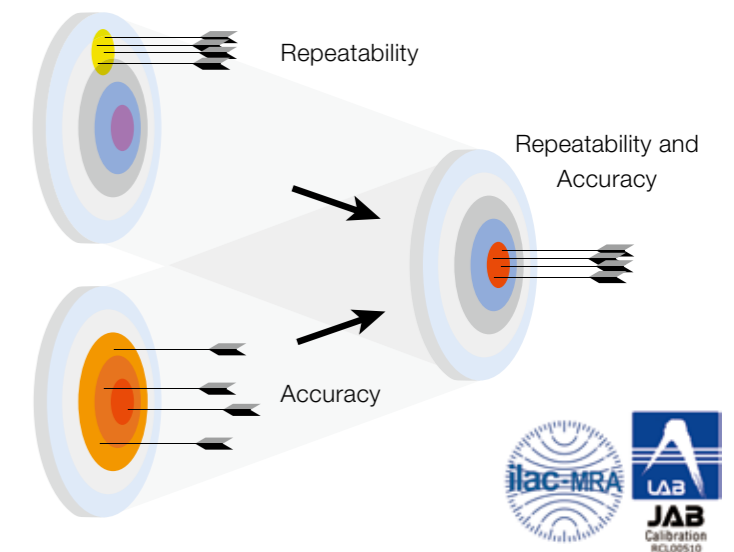

Guaranteed Measurement Performance at Your Working Environment

When you purchase DSX1000 system, calibration will be done by a technician at your site to guarantee the same level of precision as it was shipped from the factory.

A variety of certifications

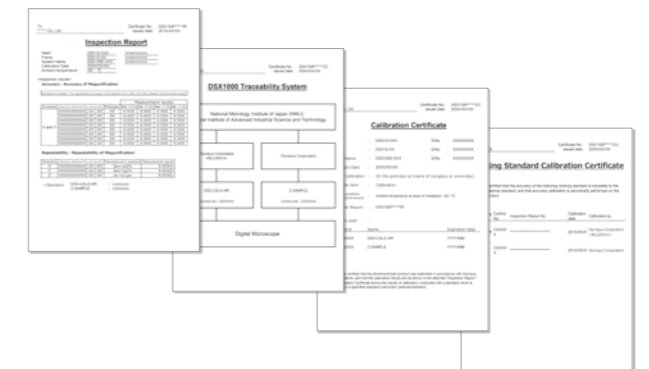

Keep Your Measurements Precise

To further reduce fluctuation in measurement precision, the objective lenses and zoom ratios needs to be calibrated. Normally, this is a time-consuming process, but calibration setting can be done quickly and easily by the auto calibration feature.



Calibration sample

What is a telecentric optical system?

Telecentric lenses have the same brightness at the center and edge of the visual field. Even if the sample moves vertically by adjusting the focus, the image size (magnification) does not change with telecentric lenses. This optical system enables you to capture an image of an entire sample faced up, which increases measurement precision.

Non-telecentric optical system

Telecentric optical system

When measuring the distance between two points in the images above and below focus, results can differ.

The measurement result is the same between the images above and below focus.

Normal lens

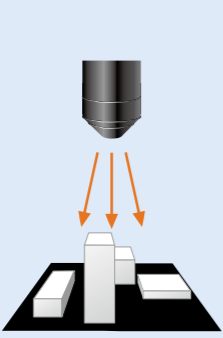

With a normal lens, the target surface can be partially hidden by unevenness.



The images are different in size.

Telecentric lens

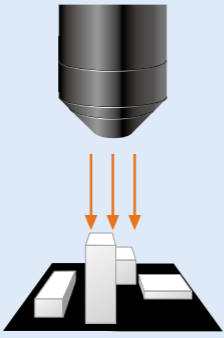

With a telecentric lens, the target surface is not hidden by unevenness.



The image size is the same.



Above focus



Below focus



Above focus



Below focus

Powerful Functionality Delivers Exceptional Value

Smooth Live Imaging with a Fast 60 fps Frame Rate

With the same technology used in high-end, digital single-lens reflex cameras, the DSX1000 offers smooth imaging at 60 frames-per-second (fps) frame rate. Your images remain sharp even if you move the sample.

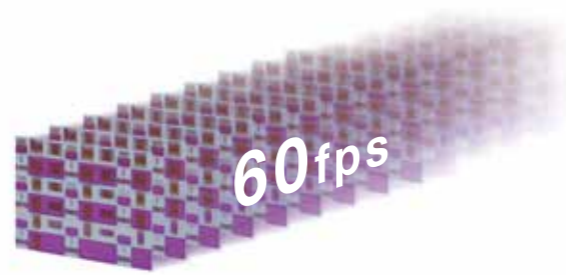

High-Resolution Imaging for High Color Reproduction

You can obtain high-resolution images with exceptional color reproduction and a small file size with the camera's built-in 3CMOS mode.

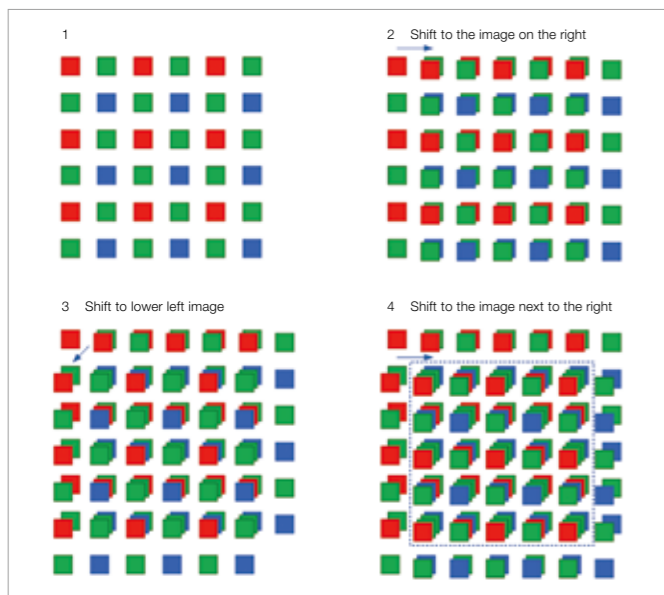

The DSX1000 system can achieve the same image quality as a three-plate camera by capturing images successively after shifting the sensor's position.

Sharp Low-Magnification Images without Flare

The microscope's advanced optical technology eliminates lens flares that are common at low magnification, resulting in sharp images.

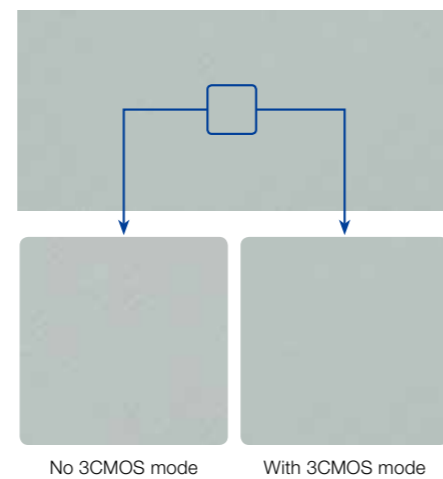

Preview Images from 6 Observation Methods

Instantly display sample images captured with 6 different observation methods by a single click. Choose the image that works best for your sample, and the setting will automatically be configured to make the best out of that observation method.

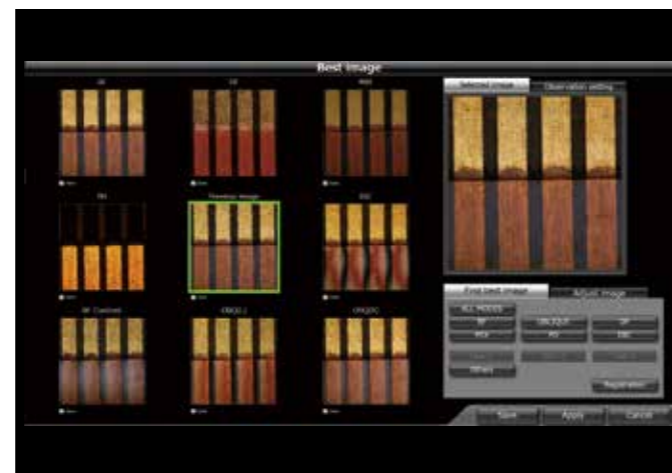

Retrieve Optimal Observation Condition

When you take an image, it contains information about the conditions when captured. You can recall these conditions by clicking on the image, making it easy to observe with the same conditions and settings.

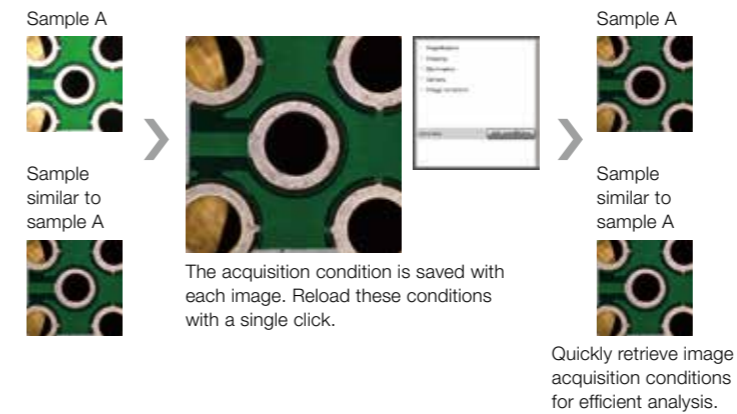

Minimize Halation

The HDR function combines multiple images captured at different exposures to show the fine structures in bright and dark areas while removing halation and glare from reflective samples.

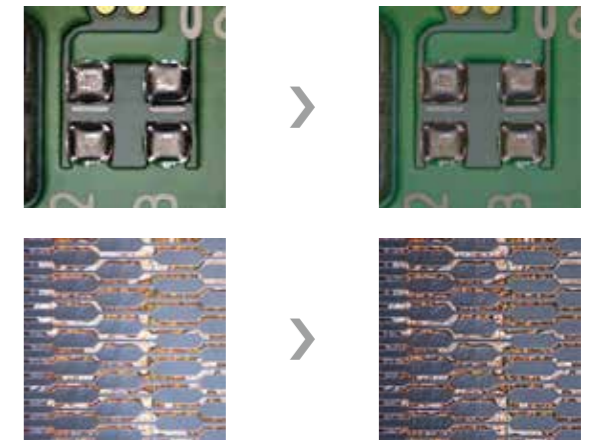

Wide Variety of Measurements

The system not only supports measurement of 2D properties like line width, surface area, angle, and diameter, but can also measure height, volume, cross-sectional area, and other properties required for 3D measurement.

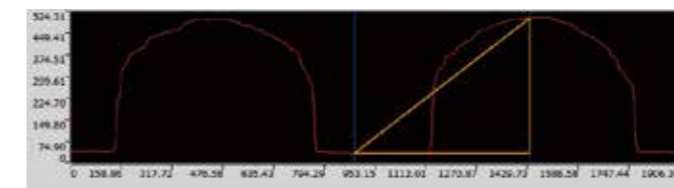
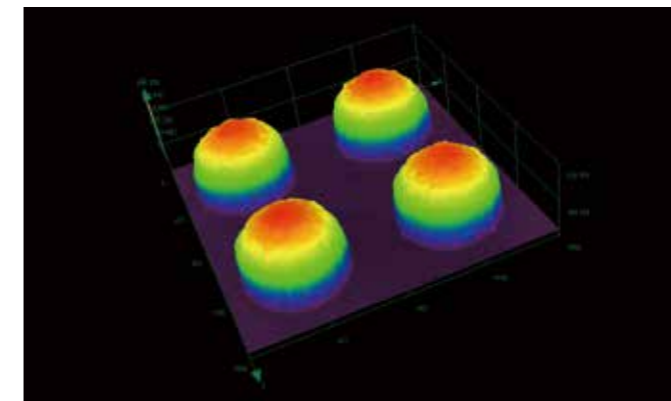

Surface Roughness Measurement

You can easily see the picture of surface condition by performing line and surface roughness measurement quantitatively, using Ra and Rz parameters.

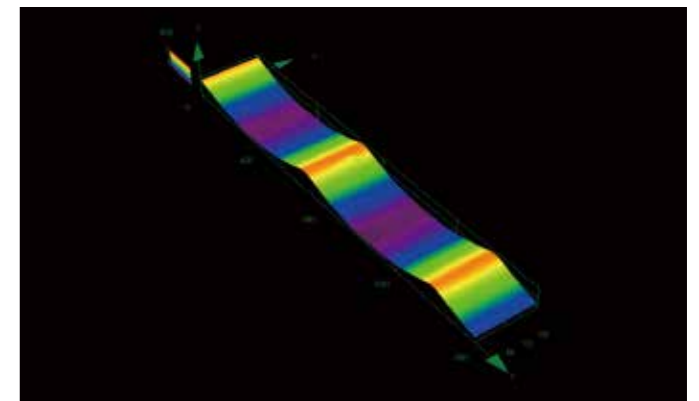

解析/パラメータ			
Sp	21.104 (μm)	Sk	0.531
Sm	1.996	Sq	46.136 (μm)
Sv	28.662 (μm)	Sz	74.790 (μm)
Sa	18.311 (μm)		

Powerful Image Analysis Software

OLYMPUS Stream image analysis software facilitates specialized analysis, such as granularity measurement. OLS5000-BWS software is also available to make your inspection, from data acquisition to reporting, more efficient.

Flexible, One-Click Reporting

Instantly report your results in the format you like. This tool supports Excel, PDF, and RTF formats in addition to DSX-specific formats. You can also customize your report according to your desired format.

Automotive

Observe foreign substances on the surface of painted car bodies to identify the source of the contamination



A painted car body

Solution

See clear object details at the same magnification.

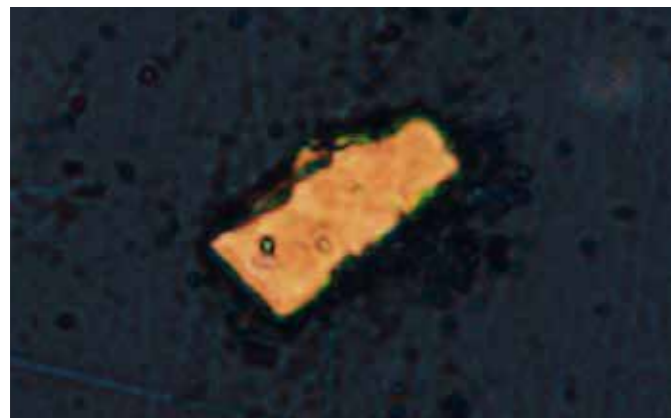

The sample is blurry when using a conventional objective (1700X)

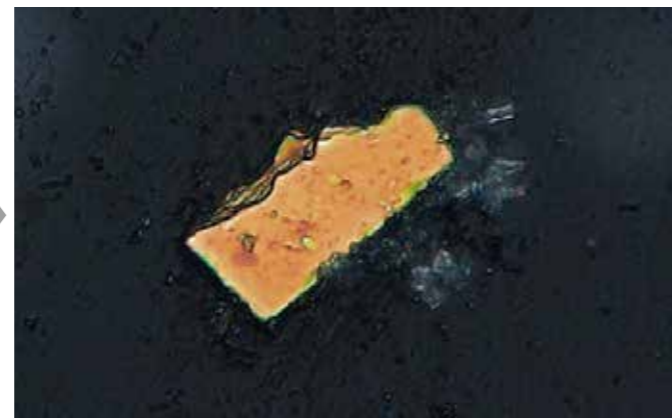

Detect foreign substances by clearly visualizing even the air bubbles around them (DSX1000, 1700X)

Observe the cross-section of radiator fins to find welding defects

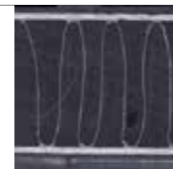

Radiator fin cross-section

Solution

With some systems, it can be time-consuming to choose the best observation method for your sample. With the DSX1000 system, select your observation method simply by pushing a button.



The sample is blurry when using a conventional objective (1700X)



DSX1000 Polized observation (300X), clearly visualize the peeling of the weld

Metal

Observe a fractured metal surface to analyze the damage cause



A fractured metal surface

Solution

Observation of a wide area can be done under high magnification with image stitching, but with some conventional system, the boundaries of stitched images remain visible. The improved stitching algorithm of DSX1000 provides clear images without visible boundaries.



A 2 x 2 stitched image (1000X)

Observe Large Objects without Glare



Drill tip

Solution

Brightness can easily be inequable when observing large three-dimensional objects, which makes it difficult to see the entire view of a sample. Obtain a clear, glare-free overview of a large object with the DSX1000 microscope.

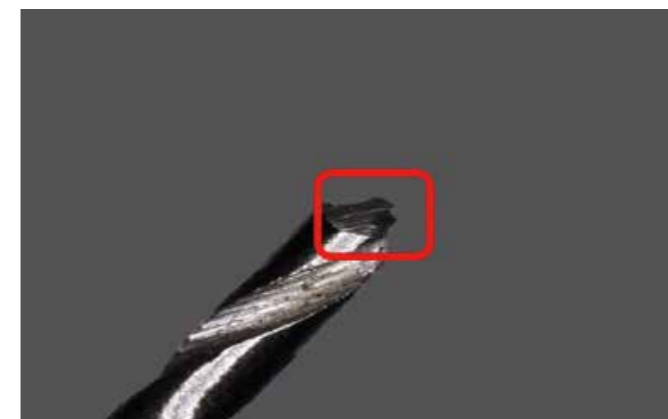

Using a conventional objective (24X), inequable brightness makes it hard to see the damaged area



Easy observation (24X) of damaged area with DSX1000 thanks to the flat lighting

Electronics

Measurement of integrated circuit (IC) chipping to determine the cause of failure

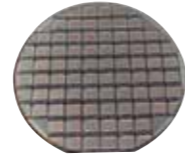

IC wafer before dicing

Solution

Not every digital microscope guarantees the accuracy and repeatability of measurements at all magnifications. You can rely on the DSX1000 measurement results with guaranteed measurement accuracy and repeatability.



Differential interference contrast (DIC) image (2500X), the edge of chipping is clearly visible

Multilayer capacitor surface inspection of defects and external dimension measurement



IC substrate

Solution

Reflection between the capacitor and dielectric makes it challenging for a conventional digital microscope to observe the entire surface. Selecting the appropriate observation method can instantly be done with DSX1000 to find the best image.

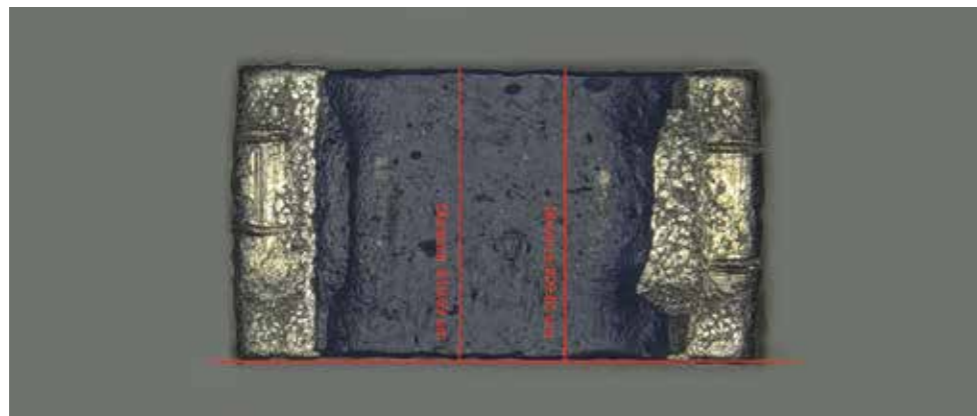

Brightfield observation (1500X), surface observation and external dimension measurement can be done at the same time

Other analysis applications

Analyze the characteristics and defects in the cross-section of metallic materials



A polished sample

Solution

The DSX1000 system with OLYMPUS Stream software is capable of acquiring a fully-focused image of the entire sample regardless of unevenness or tilt on the polished surface. This eliminates the need for re-polishing, leading to a reduction of effort and time.

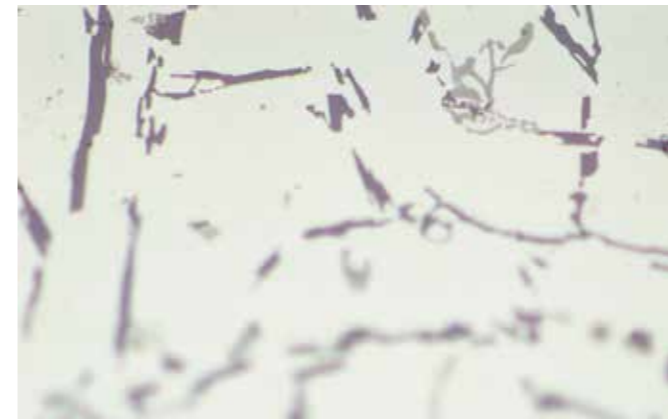

Using a conventional objective (100X), the sample is only partially in focus

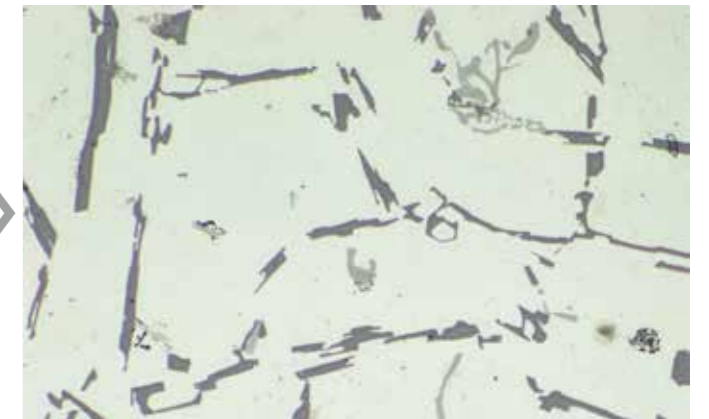

DSX1000 objective (100X), the entire sample is fully focused regardless of irregularities

Analyze the glass fibers and resin in the cross-section of a printed wiring board's glass epoxy substrate







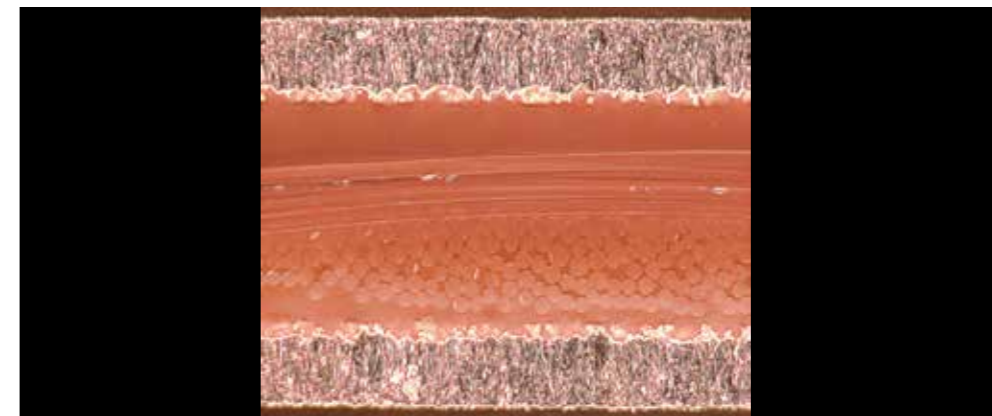

Printed wiring board

Solution

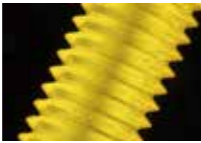
The glass epoxy's substrate is uneven due to etching, making it difficult for the microscope to clearly focus. The DSX1000 objectives' depth of focus and resolution achieve clear images across the entire cross-section.

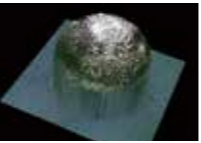

Darkfield (700X), individual glass fibers can be clearly observed

Model		Entry model	Tilt model	High Resolution model	High End model
					
					
Feature / Customer benefit		Basic functionality and easy to operate	Preferred for analyzing irregularly shaped samples	High-resolution images for advanced analysis	Analyze a wide variety of sample types using multiple observation methods
Standard equipment	Microscope motorized zoom head	Universal zoom head *DIC : Differential interference contrast *Depth of focus up *High resolution 3CMOS mode	—	●	●
		Standard zoom head	●	●	—
Observation method	BF :Brightfield	●	●	●	●
	DF :Darkfield	●	●	●	●
	OB :Oblique	●	●	●	●
	MIX :MIX	●	●	●	●
Microscope frame	Tilting frame (±90°)	—	●	—	●
	Upright frame	●	—	●	—
	Motorized XY stage with rotation (±90°)	—	—	—	●
	Manual XY stage	●	●	—	—
Console	Super long working distance objective lens	—	●	●	●
	Long working distance objective lens	*Please refer to the objectives lens lineup on page 27 – 28			
	UIS2 objective lens	*Please refer to the objectives lens lineup on page 27 – 28			
Others	Application software	●	●	●	●
	Calibration sample	●	●	●	●
	Controller PC/Display monitor	●	●	●	●
Option	Diffusion adaptor	<input type="checkbox"/>	<input type="checkbox"/>	<input type="checkbox"/>	<input type="checkbox"/>
	Eliminate reflection adaptor	<input type="checkbox"/>	<input type="checkbox"/>	<input type="checkbox"/>	<input type="checkbox"/>
	Edge detecting measurement	<input type="checkbox"/>	<input type="checkbox"/>	<input type="checkbox"/>	<input type="checkbox"/>
	Particle analysis	<input type="checkbox"/>	<input type="checkbox"/>	<input type="checkbox"/>	<input type="checkbox"/>
Others	Objectives strage case	<input type="checkbox"/>	<input type="checkbox"/>	<input type="checkbox"/>	<input type="checkbox"/>

● : Standard □ : Option

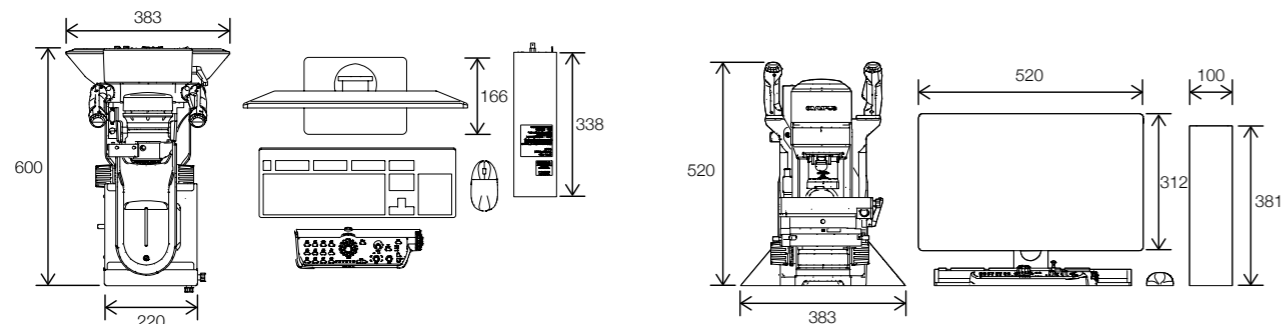

System diagram

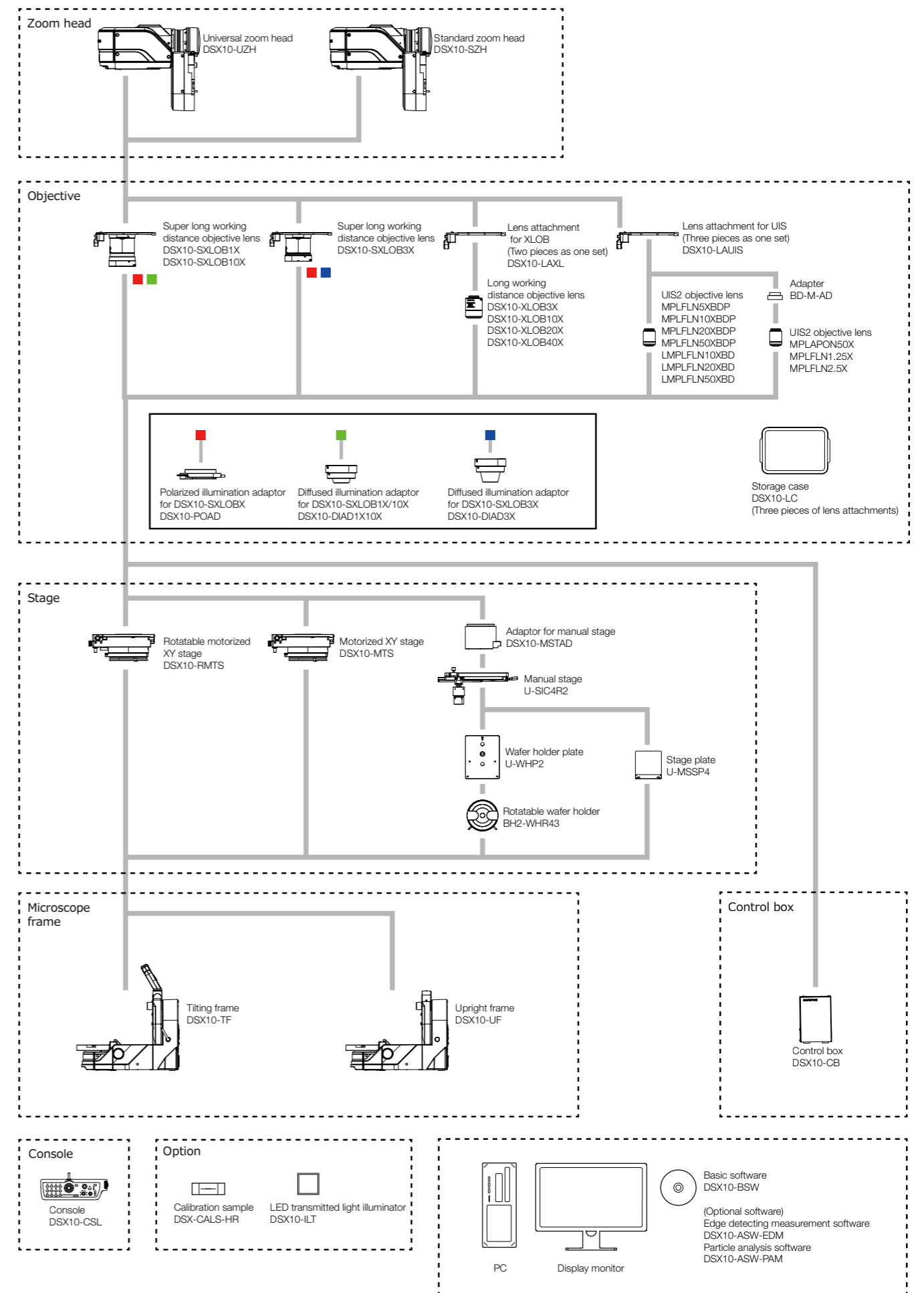

Objective Lenses

Magnification on monitor	20X	40X	100X	200X	500X	1000X	2000X	5000X	7000X	Working Distance (mm)	NA	Field of View (μm)
Super long working distance objective lens												
DSX10-SXLOB1X	20 – 200X									51.7	0.03	19,200 – 2,740
DSX10-SXLOB3X		42 – 420X								66.1	0.09	9,100 – 910
DSX10-SXLOB10X			140 – 1400X							41.1	0.20	2,740 – 270
High-resolution, long working distance objective lens												
DSX10-XLOB3X		42 – 420X								30.0	0.09	9,100 – 910
DSX10-XLOB10X			140 – 1400X							30.0	0.30	2,740 – 270
DSX10-XLOB20X				280 – 2800X						20.0	0.40	1,370 – 140
DSX10-XLOB40X					560 – 5600X					4.5	0.80	690 – 70
High-performance, high NA objective lens												
MPLFLN5XBDP			70 – 700X							12.0	0.15	5,480 – 550
MPLFLN10XBDP			140 – 1400X							6.5	0.25	2,740 – 270
MPLFLN20XBDP				280 – 2800X						3.0	0.40	1,370 – 140
MPLFLN50XBDP					700 – 7000X					1.0	0.75	550 – 50
MPLAPON50X					700 – 7000X					0.35	0.95	550 – 50
LMPLFLN10XBD			140 – 1400X							10.0	0.25	2,740 – 270
LMPLFLN20XBD				280 – 2800X						12.0	0.40	1,370 – 140
LMPLFLN50XBD					700 – 7000X					10.6	0.50	550 – 50

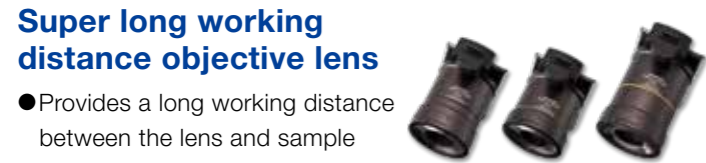

*The DSX10-SXLOB1, 3, 10X, and DSX10-XLOB3X do not support PO observation.
 *The MPLAPON50X does not support DF and mixed observations.
 *The MPLFLN1.25, 2.5X support BF and OBQ observations.

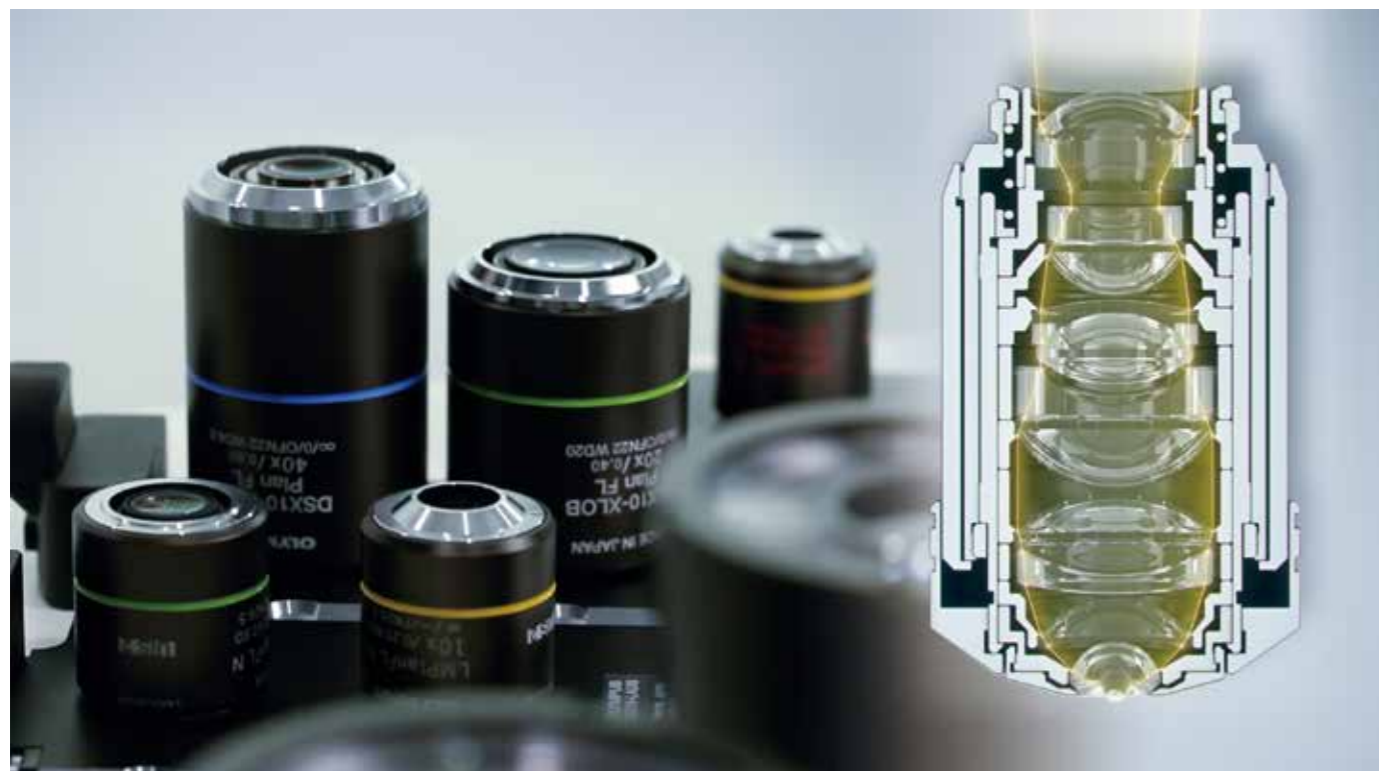

Olympus lens processing system

We created an automatic lens processing system to deliver the highest possible quality optics. As a result, we are now able to process high precision lenses as fine as 1/10,000 mm.



Olympus advanced engineer development program leads to Yellow Ribbon Medal

In 2018, Olympus was awarded a Yellow Ribbon Medal for developing an advanced method to process high-precision objective lenses up to 2 μm. As part of the program, senior engineers mentored younger engineer in the art and science of lens manufacturing.



Specifications

Main Unit Specifications

	DSX10-SZH	DSX10-UZH
Optical system	Optical system	Telecentric optical system
	Zoom ratio	10X (motorized)
	Zoom magnification method	Motorized
	Calibration	Automatic
	Lens attachment	Quick-switch, coded lens attachments automatically update magnification and visual field information
	Maximum total magnification (on monitor)	7,000X
	Working distance (W.D.)	66.1 - 0.35 mm
	Accuracy and repeatability (X-Y plane)*1	Accuracy of magnification: 3% Repeatability of magnification: $\pm 2\% = 3\sigma n - 1$
Repeatability (Z axis)*2	Repeatability (height): $\sigma n - 1 \leq 1 \mu\text{m}$	
Camera	Image sensor	1 / 1.2 inch, 2.35 million pixel color CMOS
	Cooling	Peltier cooling
	Frame rate	60 fps (maximum)
	Normal	1,200 × 1,200 (1:1) / 1,600 × 1,200 (4:3)
	Fine	Not available
Illumination	Super fine	3,600 × 3,600 (1:1) / 4,800 × 3,600 (4:3)
	Color light source	LED
Observation	Lifetime	60,000 h (design value)
	BF (brightfield)	Standard
	OBQ (oblique)	Standard
	DF (darkfield)	Standard LED ring divided into four divisions
	MIX (brightfield+darkfield)	Standard Simultaneous observation of BF + DF
	PO (polarization)	Standard
	DIC (differential interference)	Not available
	Contrast up	Standard
	Depth of focus up function	Not available
Focus	Transmitted lighting	Standard*3
	Focusing	Motorized
	Stroke	101 mm (motorized)

*1 Calibration by Olympus or dealer service technician necessary. To guarantee the accuracy of XY, calibration with DSX-CALS-HR (calibration sample) is required.

*2 When used 20X or higher objective.

*3 The optional DSX10-ILT is required.

Objective	DSX10-SXLOB	DSX10-XLOB	UIS2	
Objective lens	Maximum sample height	50 mm	145 mm	
	Maximum sample height (free angle observation)	50 mm		
	Parfocal distance	140 mm	75 mm	45 mm
	Lens attachment	Integrated with lens	Available	
	Total magnification	20X - 1,400X	42X - 5,600X	23X*4 - 7,000X
	Actual F.O.V.	19,200 μm - 270 μm	9,100 μm - 70 μm	17,100 μm - 50 μm
Adaptor	Diffusion adaptor (option)	Available	Not available	
	Eliminate reflection adaptor (option)	Available	Not available	
Lens attachment	Number of objectives that can be attached	Up to 1 piece (attachment is integrated with lens)	Up to 2 pieces	Up to 3 pieces
Objective lens case	Three lens attachments can be stored			

*4 Total magnification when using MPLFLN1.25X

Stage	DSX10-RMTS	DSX10-MTS	U-SIC4R2
XY stage: motorized / manual	Motorized (with rotation function)	Motorized	Manual
XY stroke	Stroke priority mode : 100 mm × 100 mm Rotation priority mode : 50 mm × 50 mm	100 × 100 mm	100 × 105 mm
Rotation angle	Stroke priority mode : $\pm 20^\circ$ Rotation priority mode : $\pm 90^\circ$	Not available	
Display rotation angle	GUI	Not available	
Load-resistance	5 kg (11 lb)		1 kg (2.2 lb)

Frame	Upright frame	Tilt frame	Display	23 - inch flat panel display
Z-axis stroke	50 mm (manual)		Resolution	1,920 (H) × 1,080 (V)
Tilt observation	Not available	$\pm 90^\circ$		
Tilt angle display	Not available	GUI		
Tilt angle method	Not available	Manual, fix / release handle		

System Total	Upright frame system	Tilt frame system
Weight (frame, head, motorized stage, display, and console)	43.7 kg (96.3 lb)	46.7 kg (103 lb)
Power consumption	100 - 120V / 220 - 240 V, 1.1 / 0.54A, 50 / 60Hz	

- OLYMPUS CORPORATION is ISO14001 certified.
- OLYMPUS CORPORATION is ISO9001 certified.
- All company and product names are registered trademarks and/or trademarks of their respective owners.
- Performance characteristics and other values described in this brochure are based on Olympus evaluations as of September 2017, and are subject to change without notice.
- The information including guaranteed accuracy in this brochure is based on the condition set by Olympus. For details, refer to the Instruction Manual.
- Images on the PC monitors are simulated.
- Specifications and appearances are subject to change without any notice or obligation on the part of the manufacturer.

www.olympus-ims.com

OLYMPUS[®]

OLYMPUS CORPORATION
Shinjuku Monolith, 2-3-1, Nishi-Shinjuku, Shinjuku-ku, Tokyo 163-0914, Japan