

**OLYMPUS**<sup>®</sup>

Your Vision, Our Future

3D Measuring Laser Microscope

**OLS5000**

**LEXT**

Get reliable data quickly.

**NEW**

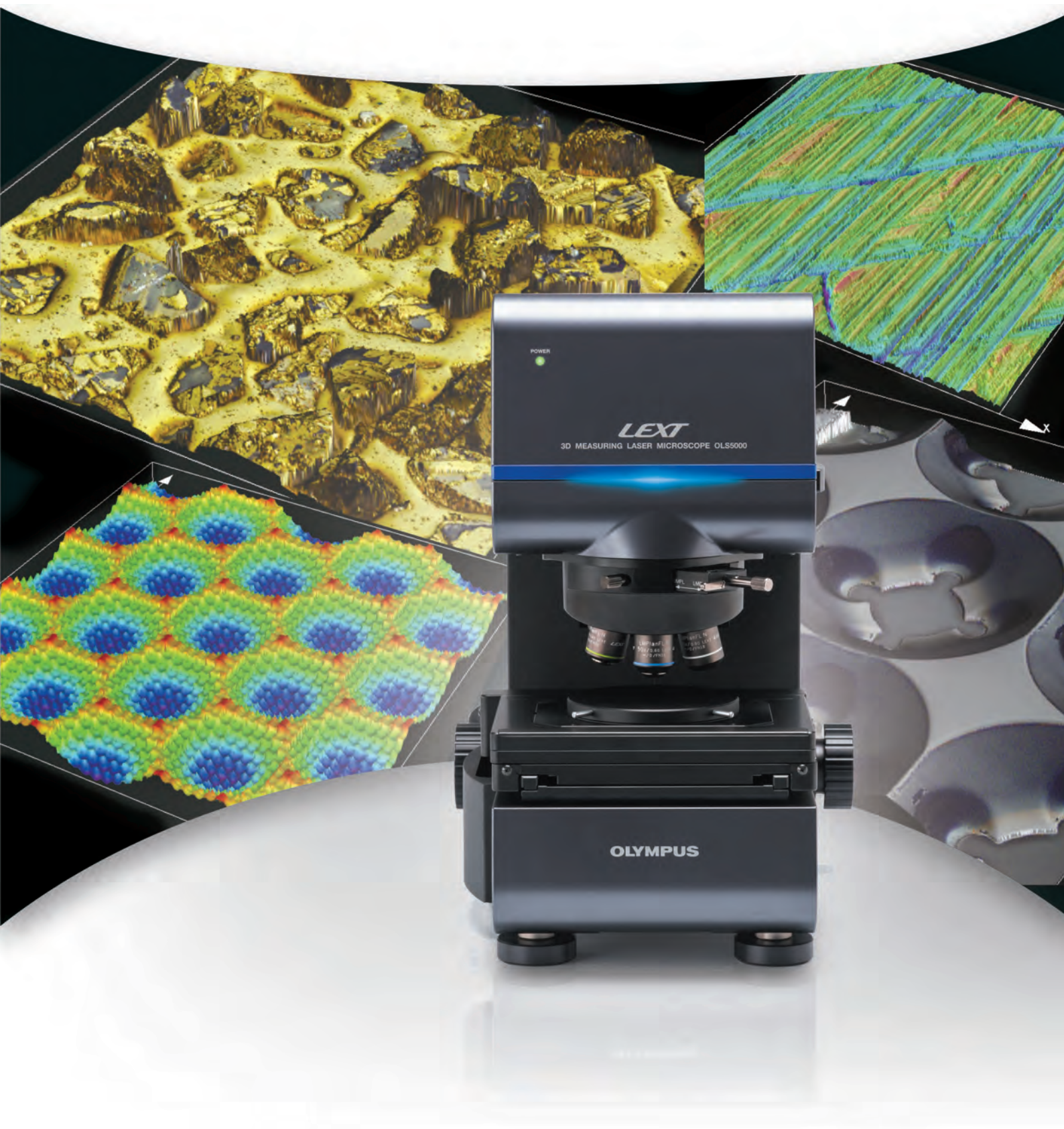



## Sub-micron 3D observation/ measurement

Observe steps in the nanometer range and measure height differences at the sub-micron level.

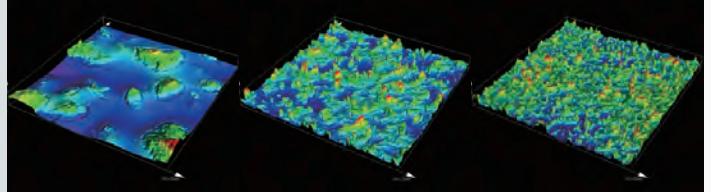

## ISO25178-compliant surface roughness measurement

Measure surface roughness from linear to planar.

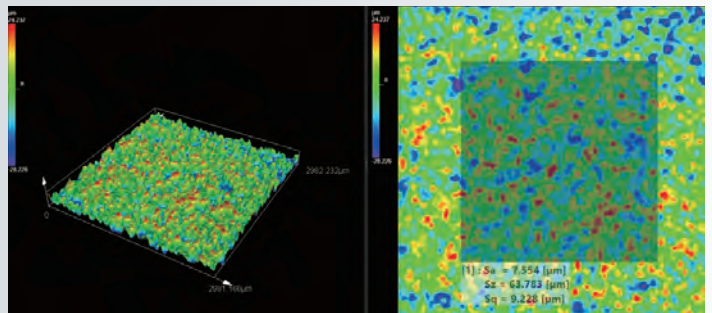

## Non-contact, nondestructive, and fast

No sample preparation required—simply place the sample on the stage and you're ready to measure.



## Conventional measuring tools

### Optical microscope, digital microscope

Unable to measure small shapes

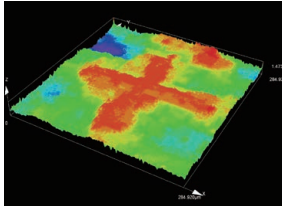

Poor lateral resolution

Non-traceable measurement results

### Stylus surface roughness tester

Can damage the sample's surface

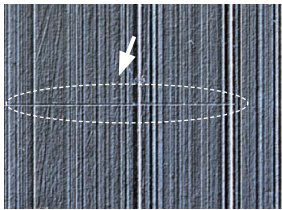

Information from only one line

Difficult to place the stylus on a target position

### White light interferometer

Has difficulty capturing rough surface shapes

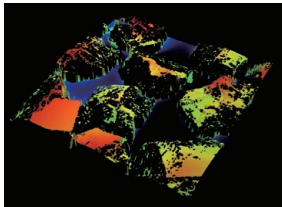

Poor lateral resolution makes positioning difficult

Inconvenient inclination adjustment

### Scanning electron microscope (SEM)

No color information

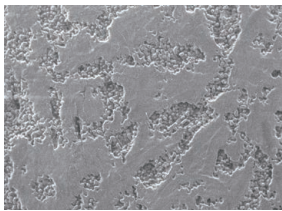

Samples must be destroyed and prepared in advance

3D shape measurement is not possible

## Laser microscope

Precision 3D measurement

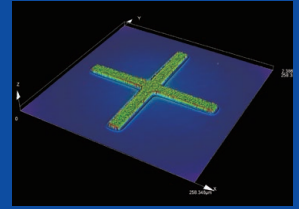

0.12  $\mu\text{m}$  lateral resolution

Traceable measurement results

Non-contact measurement doesn't damage the sample

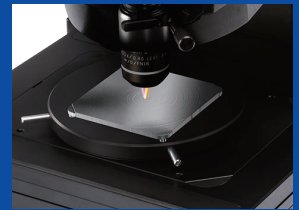

Acquire information from an entire plane

Pinpoint measurement

Accurate rough surface measurement by capturing small slopes

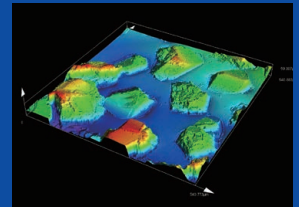

0.12  $\mu\text{m}$  lateral resolution

Just place your sample on the stage to start measurement

High-definition color observation

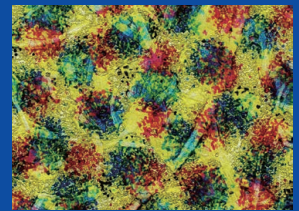

Nondestructive, and no sample preparation required

Precise 3D measurement



Capture the shape  
of any surface.

**4** Key  
Values

of the  
**LEXT OLS5000**  
3D Measuring  
Laser Microscope

Get reliable data  
quickly.

Simple to use—just  
place your sample  
and press a button.

Measure challenging  
samples.

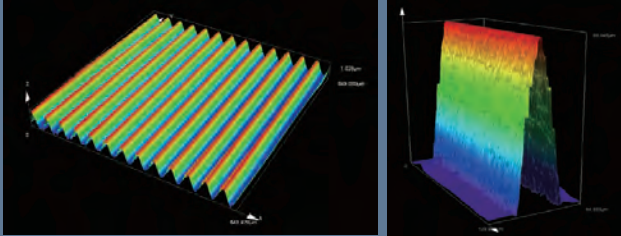

Uniform measurements in the entire visual field

## Dedicated LEXT Objectives

Capture steep slopes up to 87.5°

## 4K Scan Technology

Automatically acquire reliable data

## Smart Judge function

Value 1

▶ P. 8

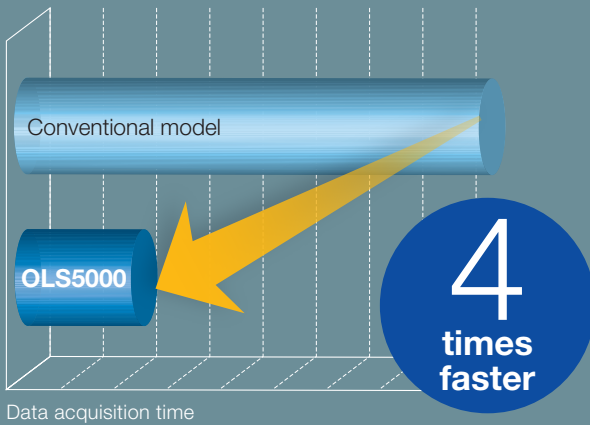

Fast, accurate measurements from low to high magnifications

## PEAK Algorithm

Save time during step shape measurements

## Skip Scan

Value 2

▶ P. 10



Acquire accurate data with the press of a button

## Smart Scan II

Create comprehensive reports

## Easy Analysis

Reduce the variance between repeated measurements

## Analysis Templates

Value 3

▶ P. 12



Accommodates tall samples (up to 210 mm high)

## Extension Frame

Measure dented areas

## Dedicated LEXT Long Working Distance Objectives

Measure parts with deep dents (up to 25 mm)

## Ultra-Long Working Distance Objectives

Value 4

▶ P. 14

# Capture the shape of any surface

LEXT OLS5000  
*Value* 1

The OLS5000 microscope's advanced technology enables it to capture high-resolution measurements of 3D samples.

## Technology that delivers reliable data

1

Uniform measurement values  
**Dedicated LEXT objectives**

Details on **P.18** ▶

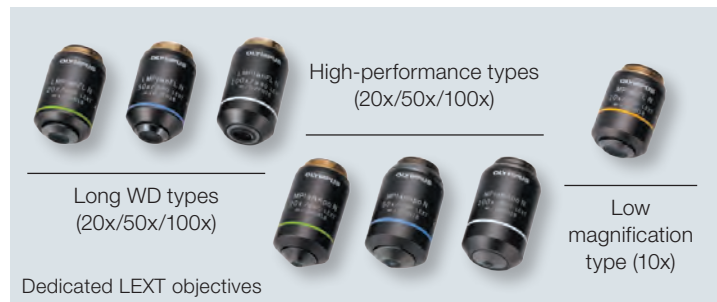

With previous lens, aberrations made it difficult to accurately measure peripheral areas.

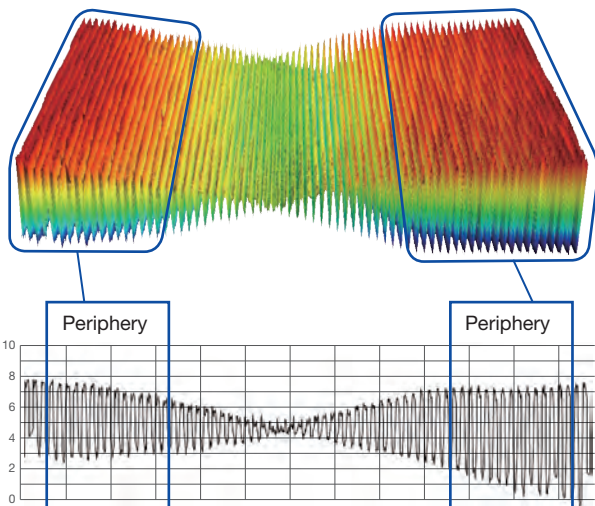

Distortion increases at the periphery.

Dedicated LEXT objective lenses can accurately measure peripheral areas.

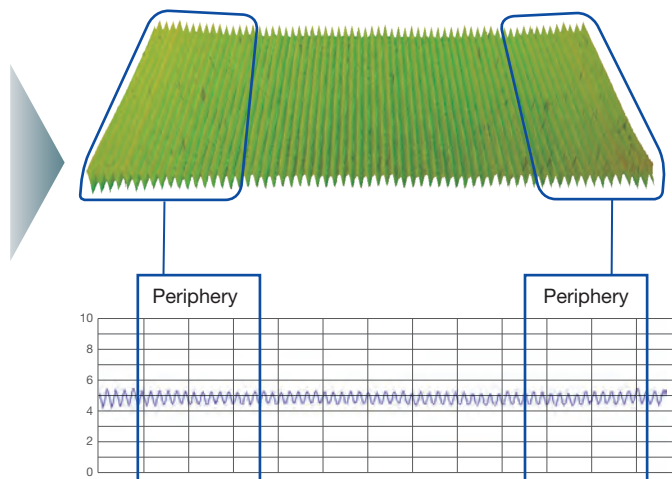

The periphery is reproduced free of distortion.

## 2 Capture the shape of steep slopes 4K Scan Technology

Details on [P.17](#) ▶

A sample with steep angles (razor blade)

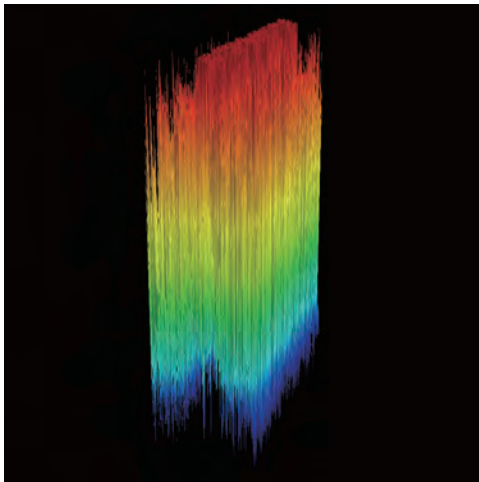

Previous model: unable to accurately measure steep slopes.

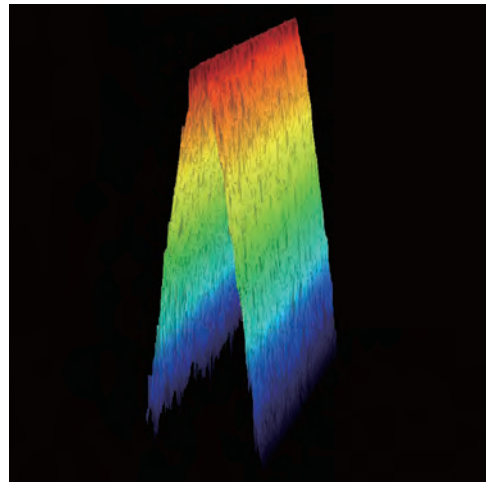

OLS5000 microscope: accurately detects slopes as steep as 87.5°.

## 3 Automatically acquire reliable data Smart Judge function

Details on [P.18](#) ▶

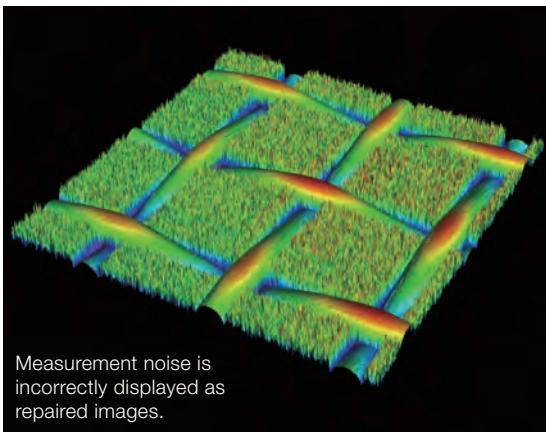

Measurement noise is incorrectly displayed as repaired images.

Previous model: Eliminating noise also eliminates original data.

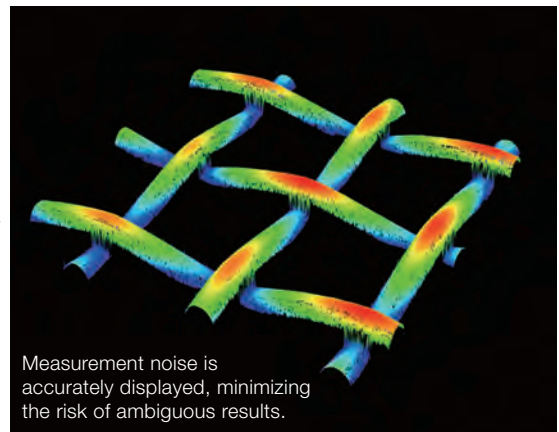

Measurement noise is accurately displayed, minimizing the risk of ambiguous results.

OLS5000 microscope: Data and noise are automatically detected for accurate shape measurements.

# LEXT OLS5000 Value<sup>2</sup>

The microscope's scanning algorithm delivers improved data quality and improved speed to reduce scan time and streamline your workflow, resulting in improved productivity.

## Technologies that deliver speed

1

### Fast, accurate measurements PEAK Algorithm

Details on [P.17](#) ▶

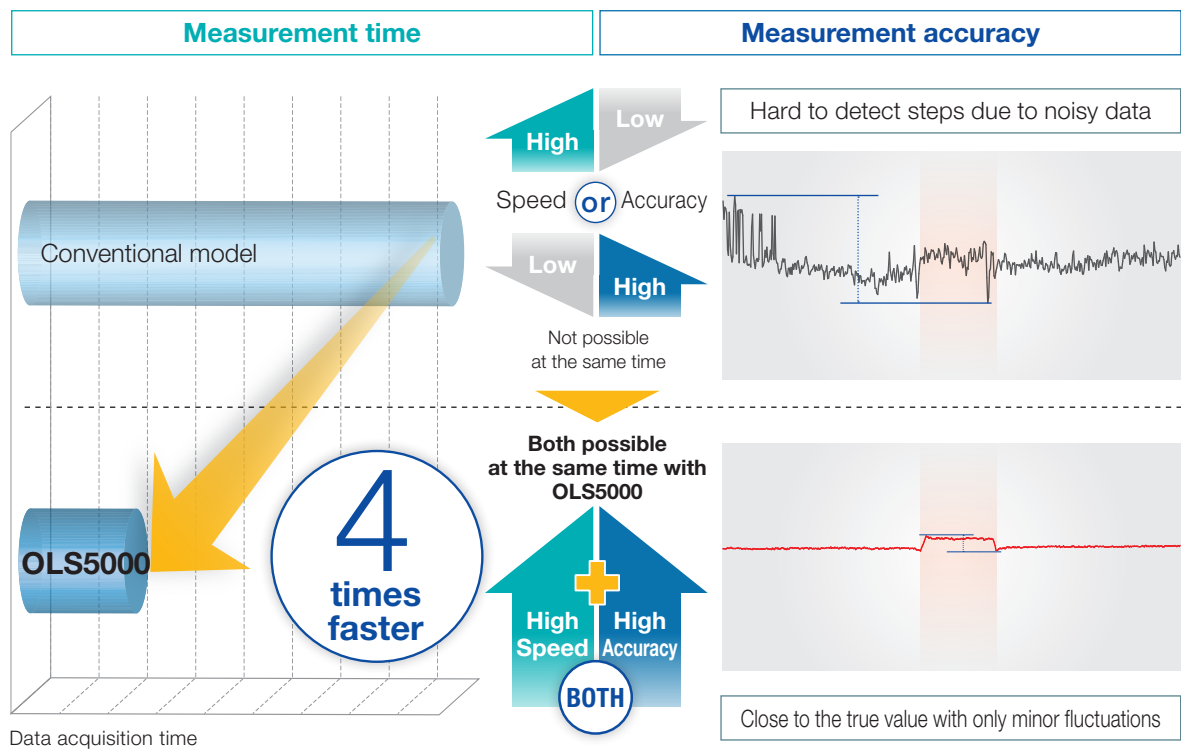

VLSI standard 83nm (MPLFLN10XLEXT)



2

## Streamlined measurement improves efficiency Skip Scan

Details on **P.22** ▶



Conventional model

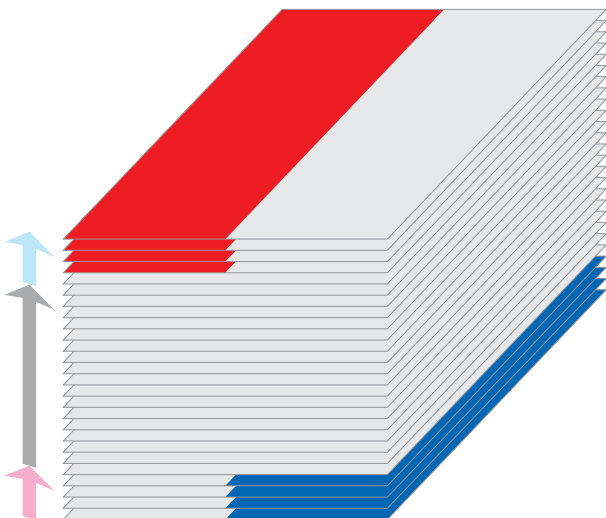

Scan every area

OLS5000

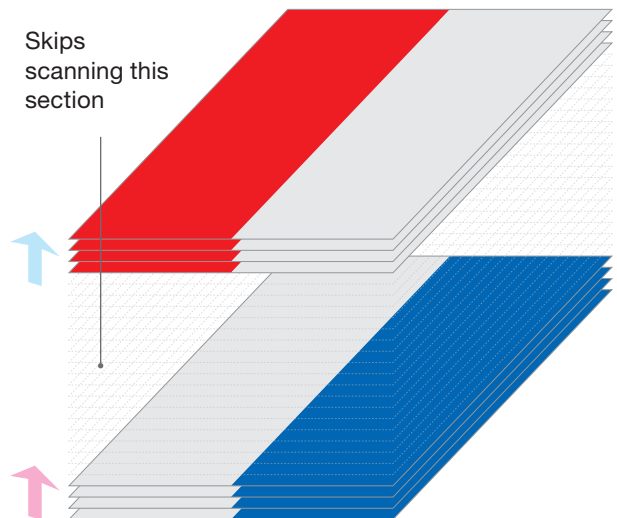

Scan required area only

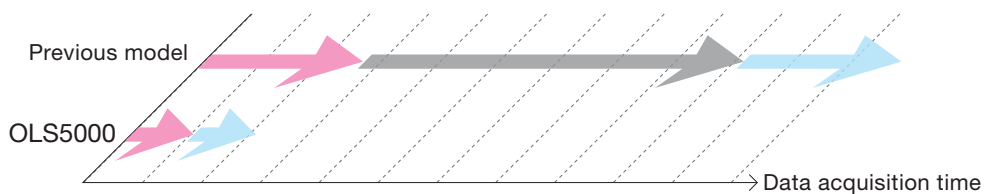

Simple to use – just place your sample and press a button

# LEXT OLS5000 Value 3

The OLS5000 microscope features automatic data capture so difficult setting adjustments are no longer necessary. Even users with minimal training can still obtain accurate results.

## Technologies that deliver ease of use

1

### Accurate data at the press of a button Smart Scan II

Details on [P.22](#) ▶

Step 1

Place the sample and set the area to be measured.

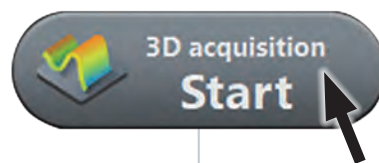

The scanning is completed.

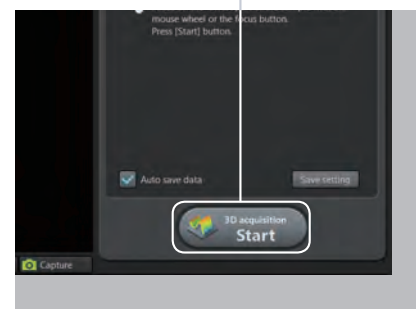
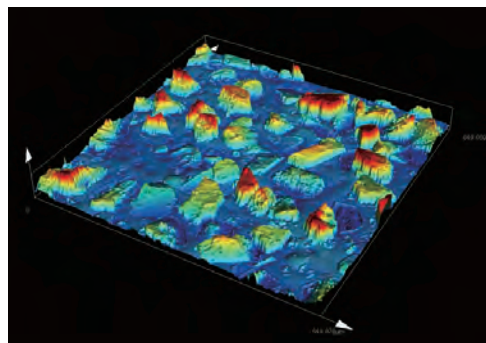

2

## Good results no matter your experience level Easy Analysis

Details on **P.24** ▶

Step 2

Specify the measurement area.

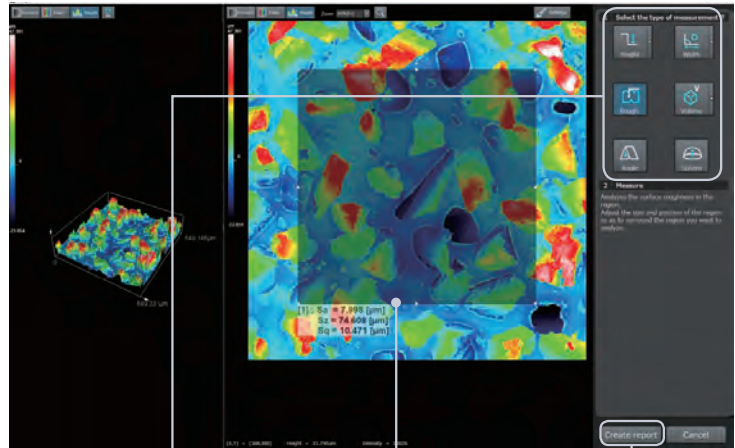

Select item

Specify area

Click report

Analysis and reporting completed.

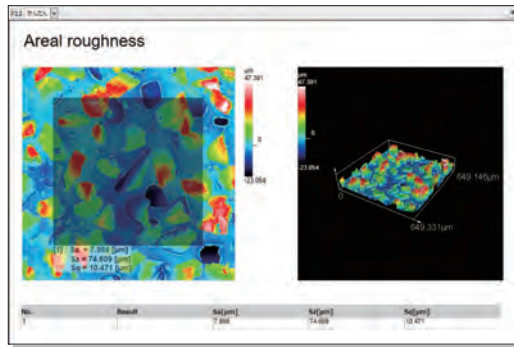

3

## Reduced variance between repeated measurements Analysis Templates

Details on **P.30** ▶

Step 3

The report is created.

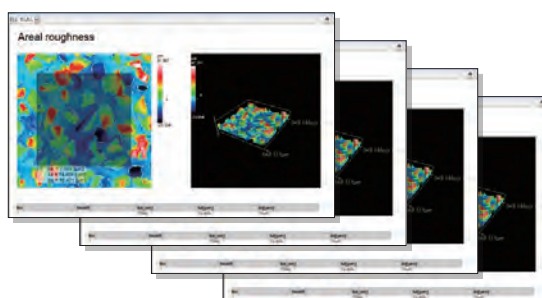

When these steps are registered as the default template, all of the steps up to create report will be executed automatically next time.

Value 3

Simple to use – just place your sample and press a button

LEXT OLS5000

Value 4

The low-output, non-contact, nondestructive laser means no sample preparation is required. Delicate materials can be measured without being damaged. The extension frame accommodates samples with a height of up to 210 mm, while the ultra-long working distance objective facilitates measurement of concavities as deep as 25 mm. In both cases, all you have to do is place the sample on the stage.

## Technologies that deliver flexibility

1

Compatible with samples up to 210 mm tall  
**Extension Frame**

Details on **P.31** ▶

### Compatible with various samples

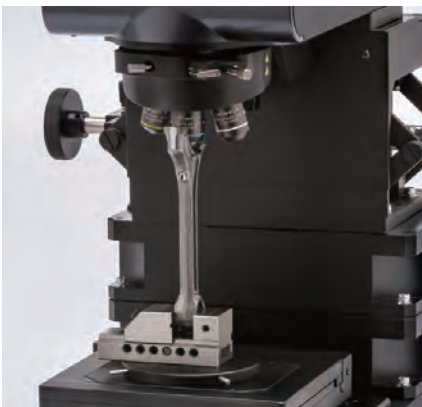

Connecting rod



Tool



Piston head



Height 210 mm

2

**High-performance measurement  
Dedicated LEXT long  
working distance objectives**

Details on [P.31](#) ▶

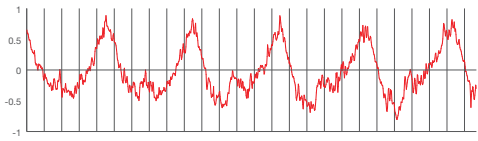
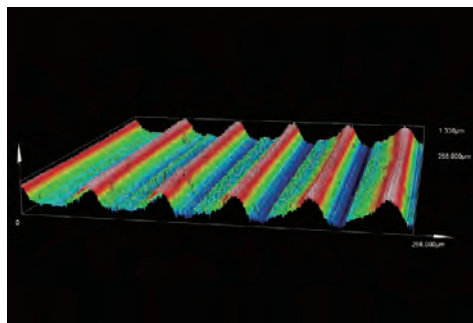

General-purpose lens (50x)

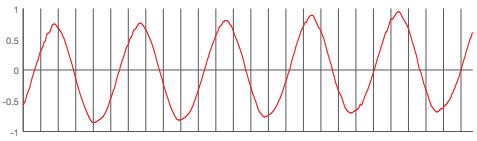
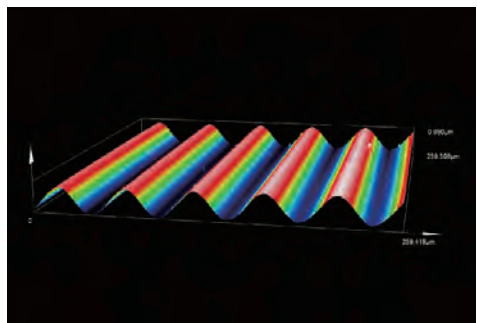

LEXT-dedicated lens (50x)

Standard roughness sample 528 by Rubert & Co., Ltd. (Pt = 1.5 μm)

169 mm

Depth (from optical axis to the frame's edge)

3

**Measure concavities 25 mm deep  
Ultra-long working distance  
objectives**

Details on [P.31](#) ▶

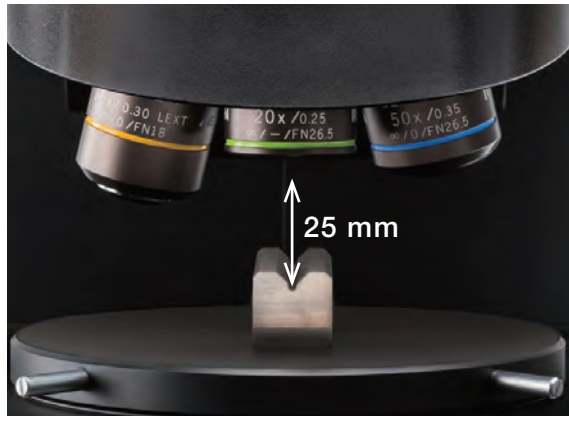

# Advanced Technology Delivers Reliable Data

## Detecting fine patterns and defects Excellent Lateral Resolution

The 405 nm violet laser and dedicated high-NA objectives make it possible to capture fine patterns and defects that conventional optical microscopes, white-light interferometers, or red laser-based microscopes are unable to detect.



Red type  
( $\lambda$  658 nm: 0.26  $\mu$ m line & space)

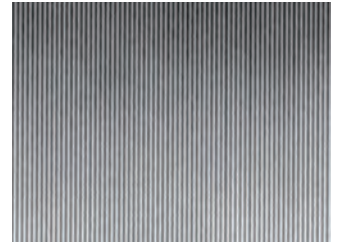

Violet type  
( $\lambda$  405 nm: 0.12  $\mu$ m line & space)

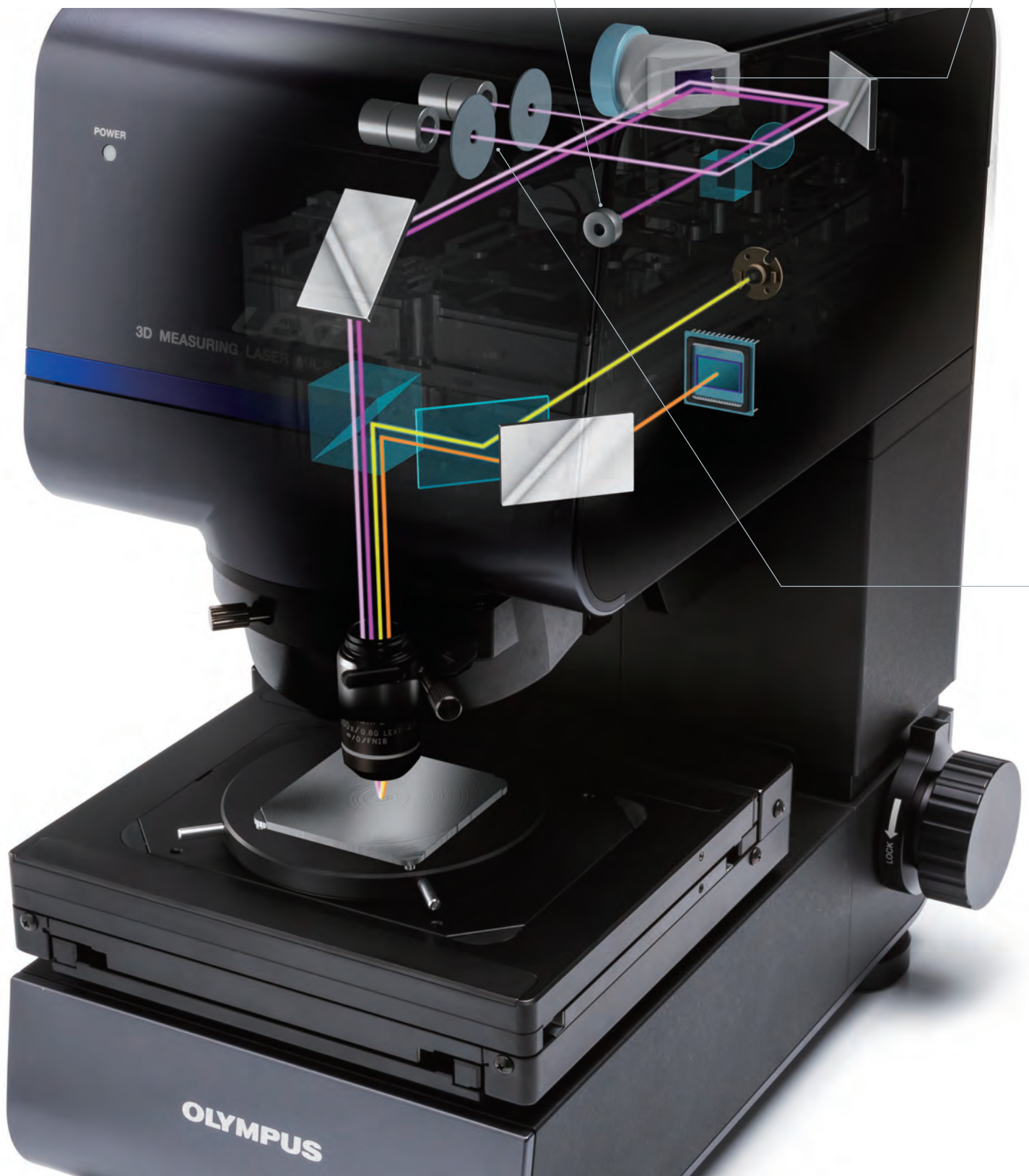

## Olympus scanning technology Newly developed MEMS Scanner **NEW**

Olympus' MEMS scanner performs accurate X-Y scanning with low scan trace distortion and minimal optical aberrations. While some laser microscopes cannot avoid fluctuations in measurements of peripheral areas, the OLS5000 microscope obtains uniform results regardless of whether the center or periphery of the visual field is being measured.

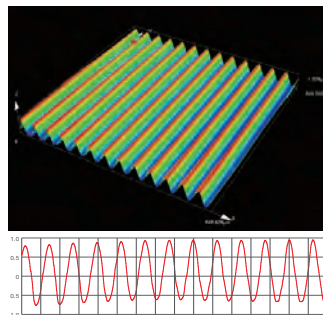

Standard roughness sample 528 by Rubert & Co., Ltd. (Pt=1.5 $\mu$ m)  
(MPLAPON20XLEXT)

## Detecting the shape of steep slopes and near-nanometer sized steps 4K Scan Technology **NEW**

The 4K scan technology scans 4,096 pixels — four times more than the conventional system — in the X-axis direction. This improves reliability in the height direction and enhances the resolution—the signal-to-noise ratio is improved by a factor of two. The OLS5000 microscope can detect slopes that are almost vertical as well as very low steps without image correction.

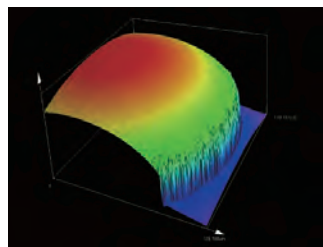

Detecting surface of 87.5° slope  
(MPLAPON50XLEXT)

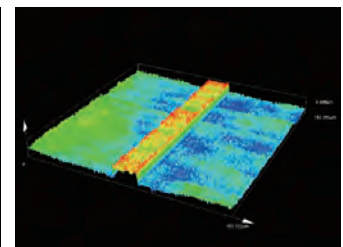

Standard 6 nm height sample by National Metrology Institute of Germany  
(MPLAPON20XLEXT)

## Fast, highly accurate measurements PEAK Algorithm **NEW**

The OLS5000 microscope incorporates a PEAK algorithm for 3D data construction. This algorithm provides highly accurate data from low to high magnifications and reduces the data acquisition time.

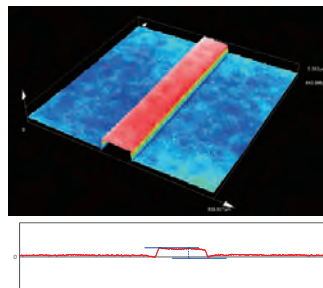

VLSI Standard 80 nm height sample  
(MPLFLN10XLEXT)

## Automatically selects the optimum channel for data acquisition Dual Confocal System

The dual confocal system is composed of two channels of confocal optics with different pin-hole diameters. The optimum channel is selected according to the lens type and data acquisition mode, enabling reliable data to be acquired quickly.

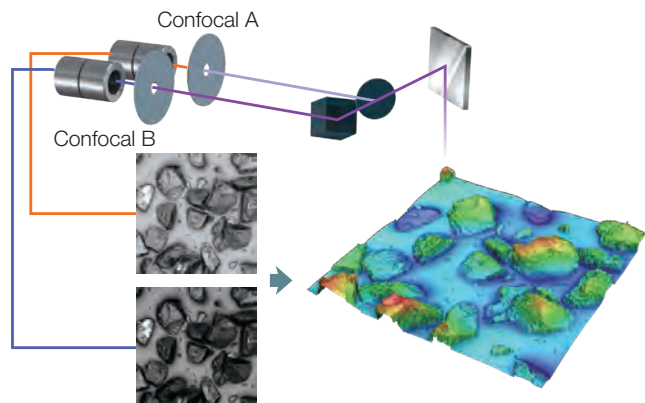

## Reliable operation Sq Noise (Measuring Noise) Guarantee **NEW**

The Sq noise is a quantization of the height detection resolution of a measuring tool. The OLS5000 microscope guarantees that the measurement noise conforms to ISO25178-700. The measuring noise is 1 nm\* with MPLAPON 100x LEXT objectives.

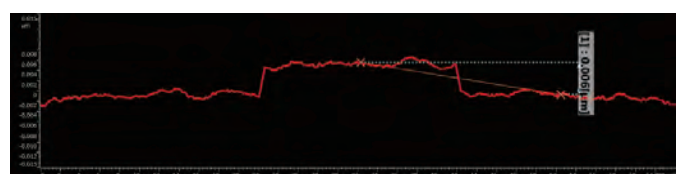

6nm height sample by National Metrology Institute of Germany  
(MPLAPON100XLEXT)

\* The results of the shipping examination are provided in the product.  
\* Typical value measured under our in-house testing conditions.

# Advanced Technology Delivers Reliable Data

## Objectives tuned for a 405 nm laser **Dedicated LEXT Objectives** **NEW**

Olympus offers a line of 10x to 100x objectives capable of reducing aberrations at a scale of 405 nm. Low power and long working distance objectives are also available in this series. The measurement performance of all dedicated LEXT objectives is guaranteed, so you can select the one best suited to the sample you're observing.



Dedicated LEXT objectives

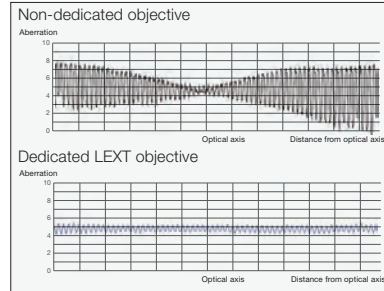

Aberrations are minimized with the dedicated objective

## Capturing the true shape **Smart Judge function** **NEW**

Because traditional laser microscopes use standard image processing techniques such as smoothing to eliminate noise, they sometimes lose accurately measured fine height irregularities along with the noise.

The OLS5000 microscope employs Olympus' Smart Judge algorithm to automatically detect only reliable data, facilitating accurate measurements without losing fine height irregularity data.

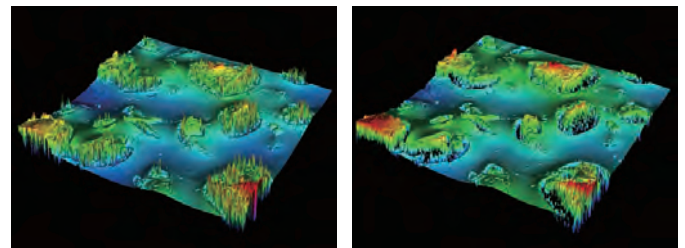

Conventional model

OLS5000 microscope  
Sanding sponge (MPLAPON20XLEXT)

## For reliable operation **Positive Traceability**

Every component used in the OLS5000 microscope, from the objectives to the laser head, is manufactured in a rigorous production system to maintain high quality. Measurement results are based on a traceability system linked to the National Industrial Standards. When the microscope is delivered, qualified engineers make final adjustments and calibrate the system to optimize the microscope for your applications.



\* Olympus issues the calibration certificate authenticated by the ILAC-MRA calibration accreditation agencies (JCSS, JAB).

## Be confident in your measurement results **Accuracy and repeatability are guaranteed**

The performance of a measuring tool is typically expressed using accuracy, which indicates how close a measurement value is to its true value, and repeatability, which indicates the degree of variation in repeated measurement values. Olympus guarantees the accuracy and repeatability of the microscope based on the traceable system so that you can be confident in your measurement results.

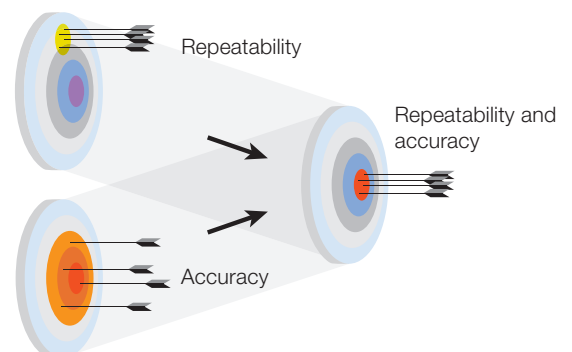



## Hybrid Matching Algorithm Surface metrology beyond the field of view **NEW**

The OLS5000 microscope incorporates a length measuring module in the motorized stage, and Olympus guarantees the accuracy of the stitched image data. While previous laser microscopes stitched data based on pattern matching, the OLS5000 microscope adds the position information from the length measuring module to the pattern matching to provide highly reliable stitched data with guaranteed accuracy.



Length measurement module

## The standard of performance you expect from Olympus Measurement performance guarantee tailored to your operating environment

With any measuring tool, it is critical that it provides optimal measurement performance in the operating environment in which it is used. If the performance of a tool is guaranteed only before shipment without considering the actual operating environment, the tool may not provide the same results once it is installed. To make sure you get the performance you need, Olympus engineers assemble, adjust, and calibrate the tool in your operating environment. The calibration certificate and examination results are issued only after the microscope is successfully installed, so you'll be able to operate the system with confidence.

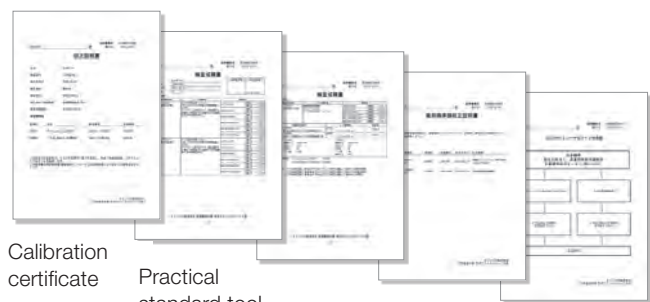

Calibration certificate

Practical standard tool calibration certificate

Examination results document

OLS5000 microscope traceability system chart

## Equipment inspection with a single click Accuracy Management Function (Available in 2018) **NEW**

When recording measurement results as evidence, managing the equipment's status is important. The OLS5000 microscope provides an inspection function to check the equipment's status before each measurement as well as a calibration sample (optional) with a calibration certificate. The calibration sample makes it possible to complete the inspection work with a single click and insert the calibration results as a record in the report.



X-Y calibration standard  
OLS50-CS-XY

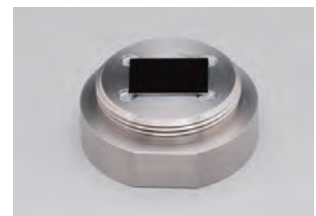

Z calibration standard  
OLS50-CS-Z

## Rigidity and vibration resistance for various installation environment Hybrid Dampening Mechanism

The OLS5000 microscope incorporates a vibration dampening mechanism that uses coil springs and dampening rubber to stabilize the operating environment.



Hybrid vibration dampening mechanism

## Worldwide service locations Global service system

Olympus delivers global technical support from service locations around the world (Japan, the United States, Germany, China, South Korea, Singapore, Taiwan, India, and Australia). Each service location has engineers with technical licenses for laser microscopy as well as a proven calibration system to help ensure reliable use after installation.



# User-Friendly High-Resolution/High-Magnification Observation



Keeping track of the sample's position

## Real-time macro mapping **NEW**

When the stage moves, the system creates a panoramic macro map that stitches images on the moving trace in real time to help users from getting lost in the sample.

The macro map image can also be inserted in the report, helping link magnified images of the sample with their overall location.

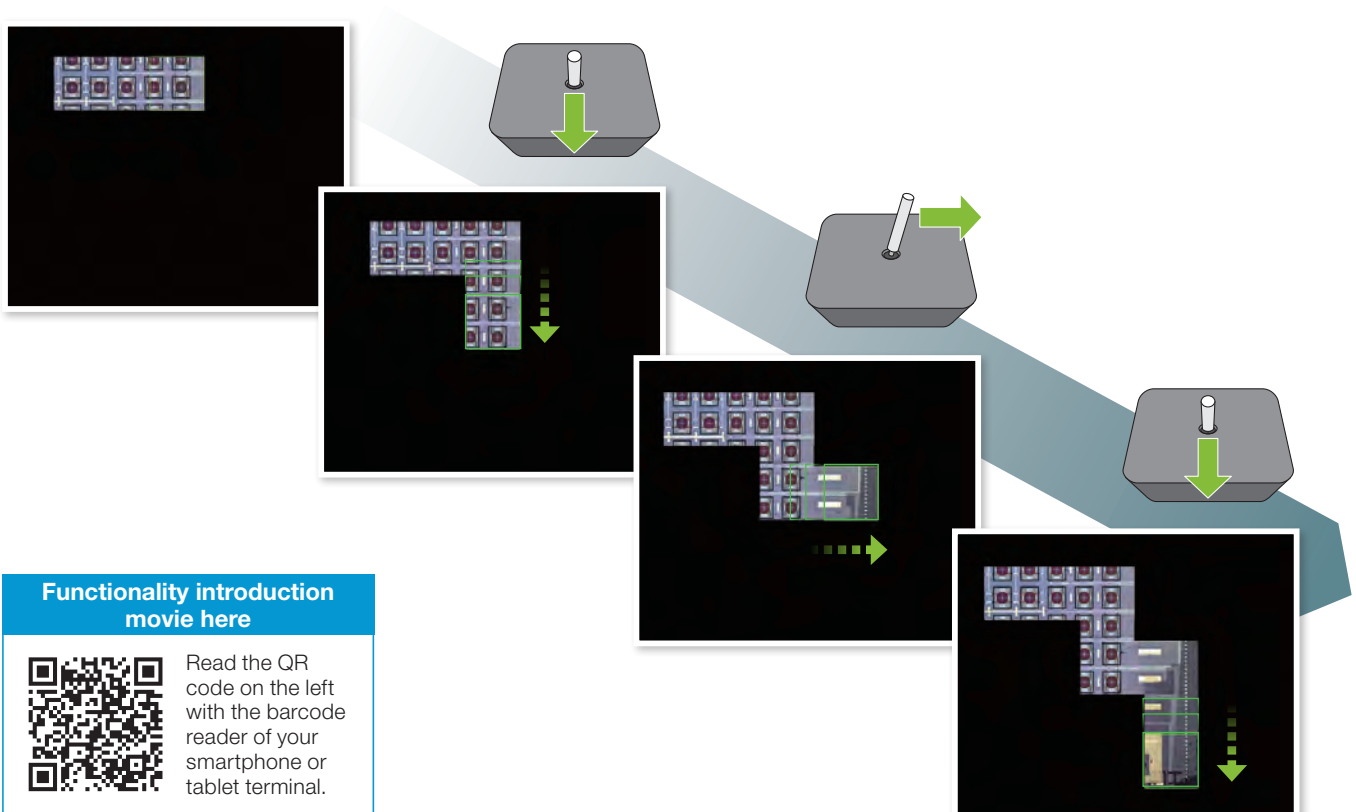

## Solving focusing problems

### Continuous auto focus **NEW**

The microscope's continuous autofocus minimizes the need for manual adjustments because the image remains in focus during a position search or when changing objectives. Permanent focus tracking enables users to quickly and reliably perform observations.

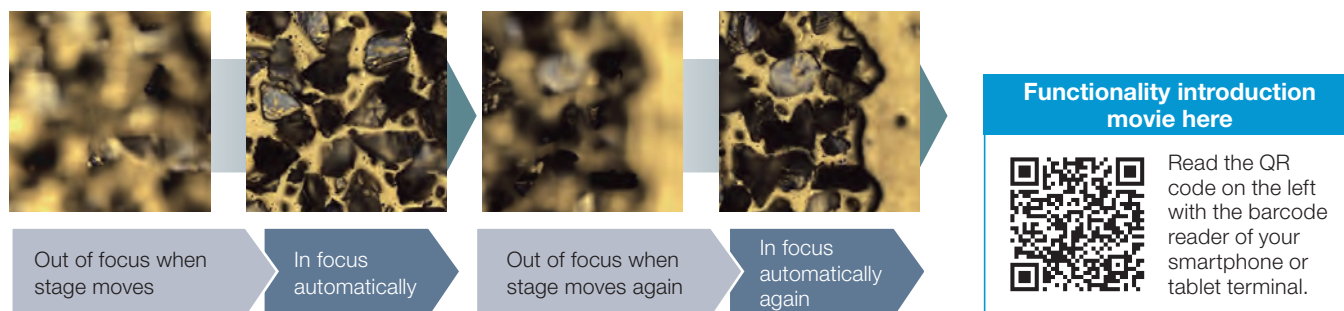

## Detecting nanometric irregularities

### Dual DIC for nano-scale real-time observation

Differential interference contrast (DIC) observation is used to visualize nanometer-scale surface contours that are normally beyond the resolving power of a laser microscope, even when a 5x or 10x low-power objective is used. Thanks to its DIC laser mode, the OLS5000 microscope can obtain live images comparable to those of an electron microscope, even under relatively low power magnifications. Real-time observation of nanometer-scale scratches and defects helps the microscope image even minute damage.

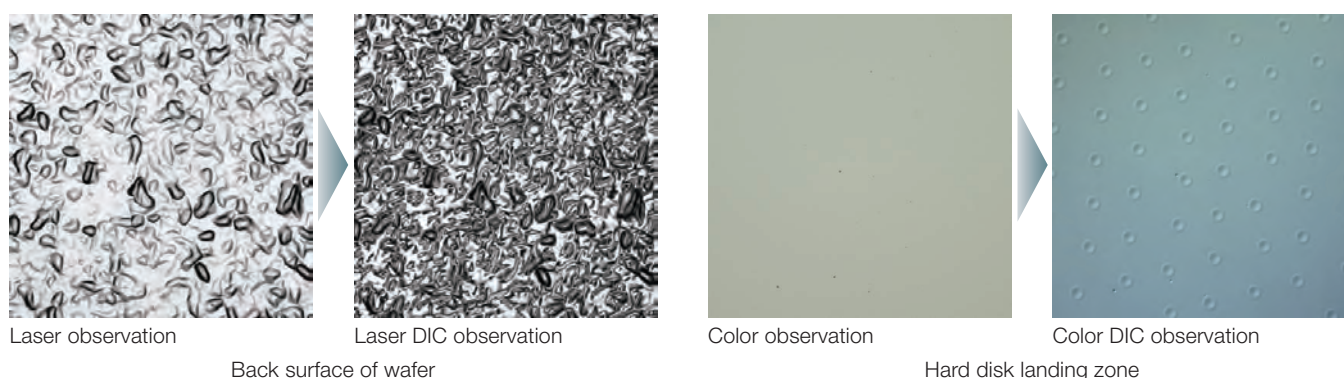

## For clearer observation

### Color HDR Observation

Observe fine shapes on samples with low contrast or those that cause halation in real time with the microscope's high dynamic range (HDR) function. HDR captures multiple images at different exposures and combines them.



## Color and laser observation

### Dual observation

Users can simultaneously observe a laser image and a high-resolution, color image. This is useful for evaluating differences in color or for assessing corrosion on metallic surfaces, as well as focusing on very low-contrast samples, such as a mirror surface or film.

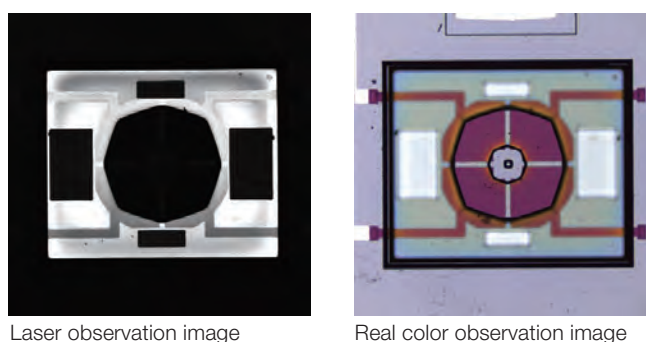

# Advanced Smart Scan II Function

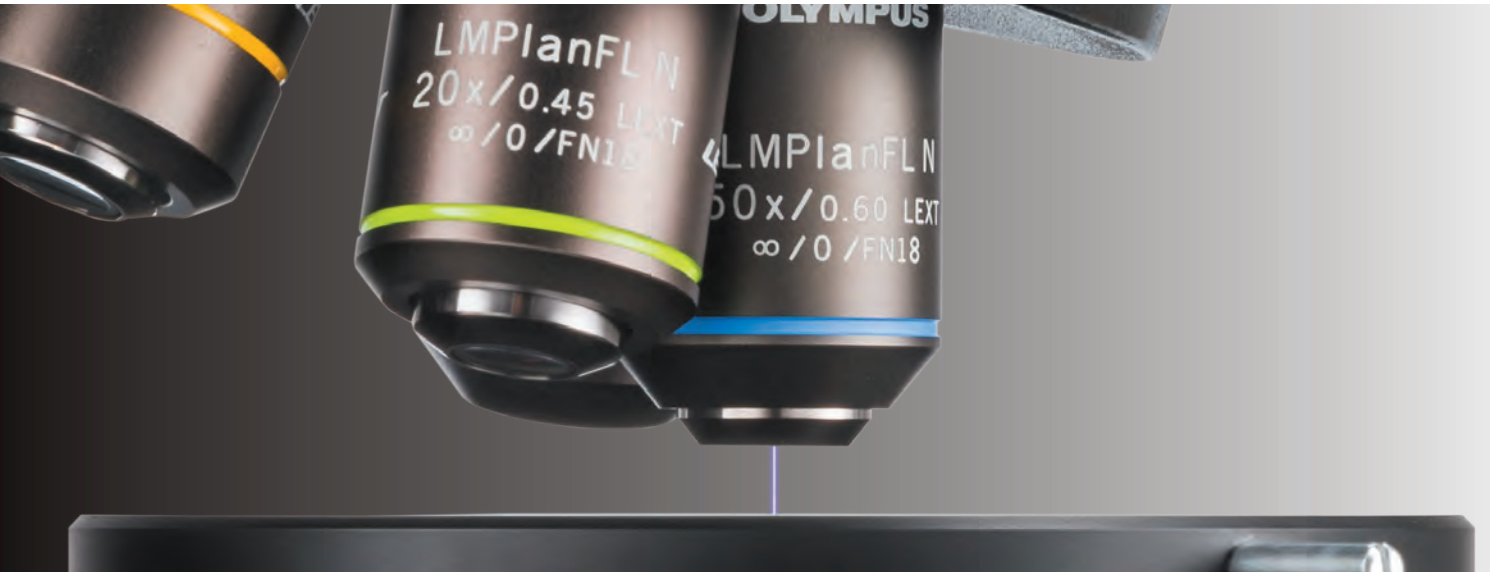

## Fully automatic 3D data acquisition just by pressing the start button **Smart Scan II** **NEW**

Acquiring data with a laser microscope requires manual adjustments, but Olympus' Smart Scan II automates these adjustments to minimize variation in the acquired data and maximize efficiency.

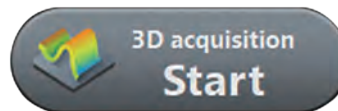

### Functionality introduction movie here



Read the QR code on the left with the barcode reader of your smartphone or tablet terminal.

### Why Smart? **1** Scan speed

Olympus' PEAK algorithm and bi-directional scanning perform measurement four times faster than the conventional model. Light detection sensitivity and data acquisition range are no longer necessary, dramatically improving work efficiency.

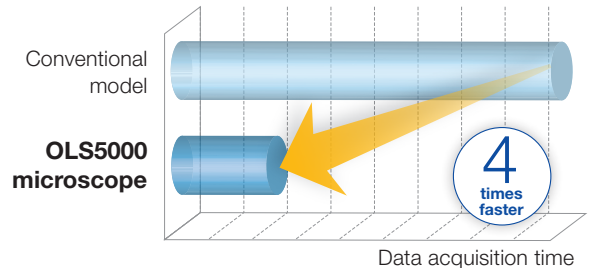

### Why Smart? **2** Skip scan

When measuring the shape of steps on a sample containing near-vertical planes, such as an electronic component or MEMS, the data acquisition time can be reduced by skipping the unnecessary scanning range in the Z-direction. A 700  $\mu\text{m}$  step can be measured in about 15 seconds without degrading the accuracy (when the MPLAPON20x is used).

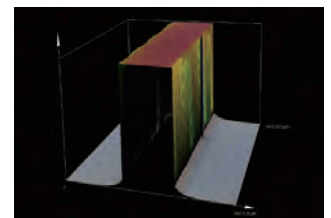

Resist pattern on silicon surface

Courtesy of Nanotechnology Hub in Kyoto University

### Why Smart? **3** HDR scan

Depending on the conditions of the sample and the objective lens, it is not always possible to acquire accurate shape data. The OLS5000 microscope features an automatic judgment system that adjusts to the requirements of each sample. The HDR scanning acquires two sets of shape data by varying the detection sensitivity and uses these to build accurate shape data.

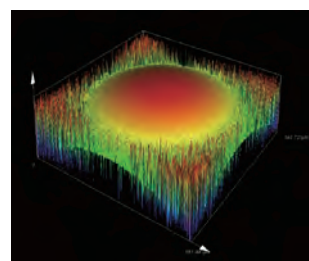

Previous model

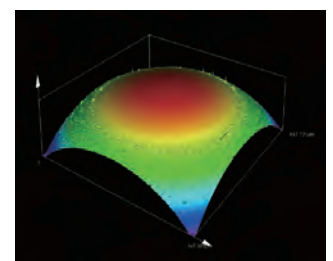

OLS5000 microscope

## Capable of handling a wide range of measurements Extensive data acquisition modes

The OLS5000 microscope incorporates a wide selection of data acquisition modes. These include the 1-area mode that can simultaneously acquire a color image, laser image and 3D shape data in a single field, the 1-line mode that acquires the shape of a single line in the center of the field, and the film thickness mode that can measure the thickness of a thin film.

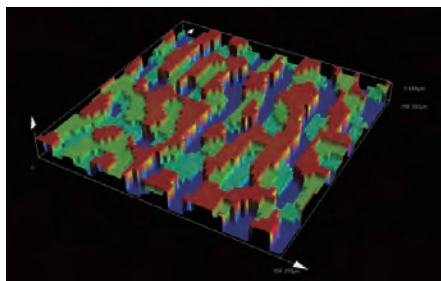

1-area (color image, laser image, 3D shape)

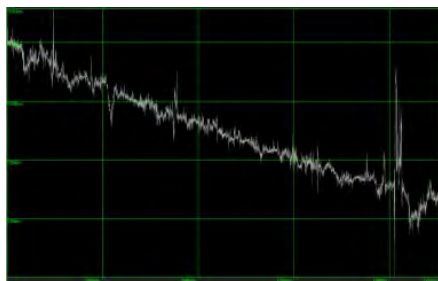

1-line (shape)

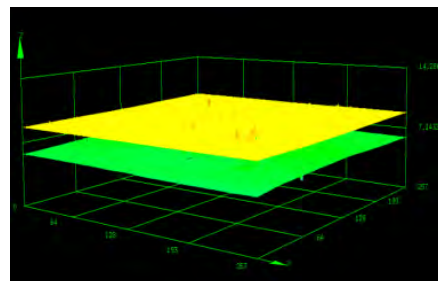

Film thickness (multi-layer mode, fault mode)

## High-resolution measurement from a wide field Stitching mode

Accurate data can be obtained from a wide field of up to 36 million pixels by stitching data in a planar direction. The target area can be easily specified on a macro map. The specified stitching area can be saved and recalled later.

\* The stitching mode for film thickness data will be available in 2018.

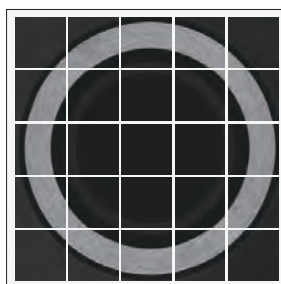

Individual 2D images before stitching



2D image after stitching

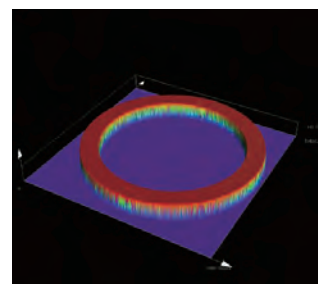

2D image after stitching

## Analyzing the shape of the top surface of a transparent film Top surface detection filter **NEW**

When transparent films are layered on the sample's surface, the laser microscope can detect the interface with the highest reflected light intensity. The top surface detection filter uses polarization characteristics to facilitate the detection of the shape of the top surface.

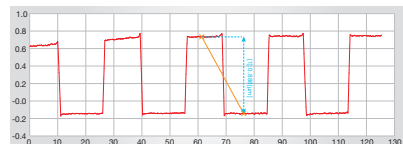
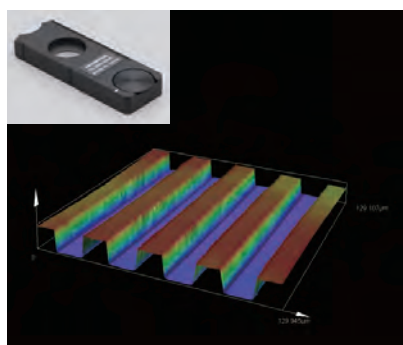

Resist pattern on silicon substrate (MPLAPON100XLEXT)  
Courtesy of Nanotechnology Hub in Kyoto University

## High-speed acquisition from only the required areas Band scan

In 1-area or film thickness mode for limited target areas, band scan changes the data size in the Y-direction to acquire the data in required areas at higher speed.

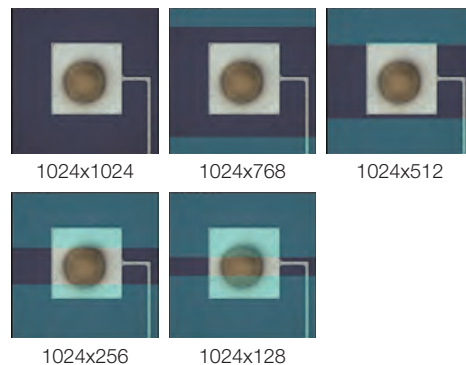

## Image detailed damage and surface irregularities Ultra high-definition (UHD) mode

The ultra high-definition mode is useful when the optical resolution is larger than the size of a single pixel. It makes it possible to accurately capture fine shapes without augmenting the lens or the zoom magnifications.

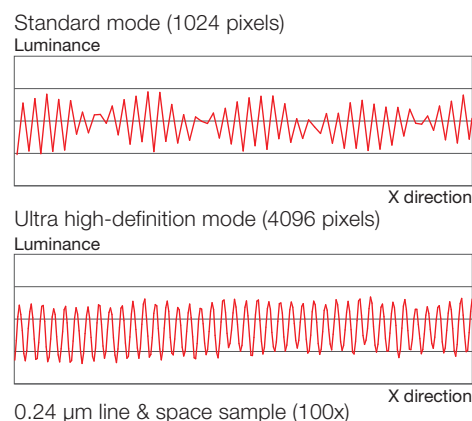

# Analysis Functions that Help Minimize the Differences Between Operators

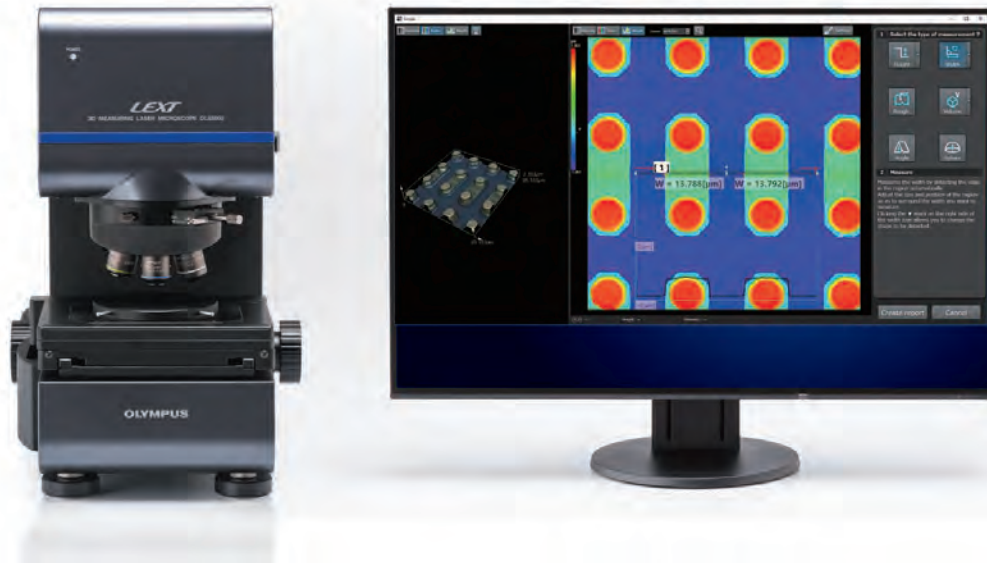

## Specify the measurement area Simple analysis **NEW**

The simple analysis function measures the step, line width, surface roughness, and volume only in the specified measurement areas. The causes of variance in the measurement results, such as the edge position and the threshold of the reference planes in volume analysis, are automatically detected so that the measurement results are stable and not affected by the operator's skill level.

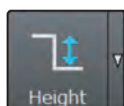
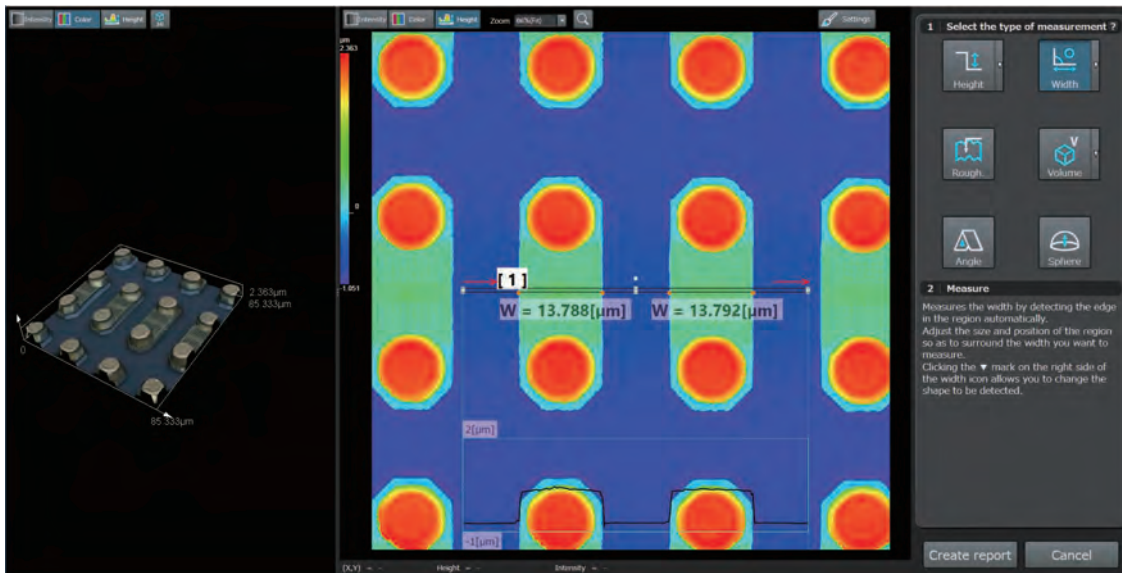

Measurement of the step height difference and distance between two specified regions



Measurement of the difference in angle between two specified regions

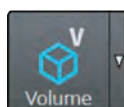

Measurement of the volume in the specified region

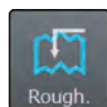

Measurement of the surface roughness in the specified region

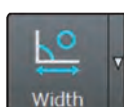

Measurement of the width by automatically detecting edges in the specified region

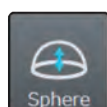

Measurement of R and the height from the reference plane based on the automatic recognition of a circular shape in the specified region

**Functionality introduction movie here**



Read the QR code on the left with the barcode reader of your smartphone or tablet terminal.

### Optimum correction with a single click **Auto correction** **NEW**

Some laser microscopes require preprocessing, such as noise elimination and inclination correction, of the acquired data, slowing down the scan time and increasing dependency on the skill of the operator. With the OLS5000 microscope, processing that automatically eliminates measurement noise without removing accurate data (Smart Judge), as well as processing that renders the automatically detects the main horizontal plane (reference plane) at the height zero position (Smart Leveling) can be executed with a single click. There are no complicated settings, so the operator's skill and experience have minimal impact on the results.

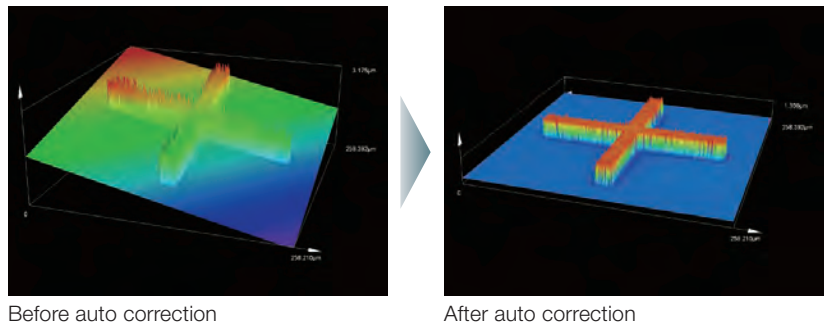

Before auto correction

After auto correction

### Optimum correction with a single click **Profile measurement**

The profile measurement function displays the surface profile by arbitrarily drawing a measurement line on the position to be measured on an image. It also measures the step between any two arbitrary points, width, cross-sectional area, and R. Unlike contact-based measuring tools, setting the measured positions is easy. The measurement lines and points can be checked on the image, so even a very small site can be measured accurately.

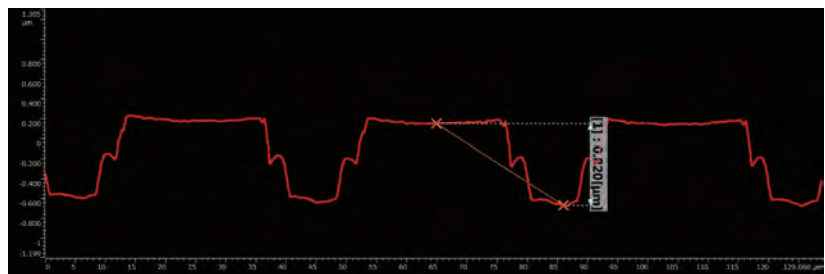

Surface profile

### Drawing a measurement line on the target position **Profile assist tool** **NEW**

The desired measurement line can be designated by specifying the maximum/minimum points on the specified site, the intersection of two lines, center of a cylinder, or center of a sphere. When a site is specified in the acquired data, feature points are automatically extracted according to specified conditions, reducing operator-related variations.

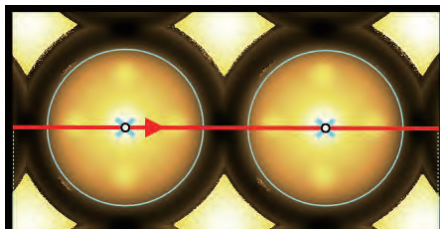

Specification of a measurement line passing through the center of a sphere

### Reliably specify measuring points **Measurement assist tool** **NEW**

The point to be measured can be correctly specified using the highest, lowest, middle, and/or mean points. When a site is specified in the acquired data, the feature points are automatically extracted according to specified conditions.

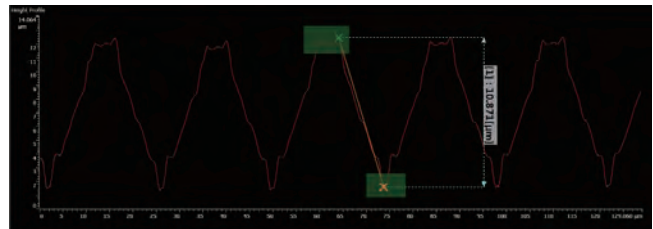

Measurement of the step between the highest and lowest points in a surface profile



# Comprehensive Analysis & Reporting Functions

## ISO4287 compliant Line roughness measurement

A contact surface roughness gauge is incapable of precisely measuring the target position on a tube or wire because of the difficulty of placing the stylus on a very small site. The OLS5000 microscope enables operators to specify the measurement line after data acquisition from the surface so that the line roughness of a small target can be measured easily.

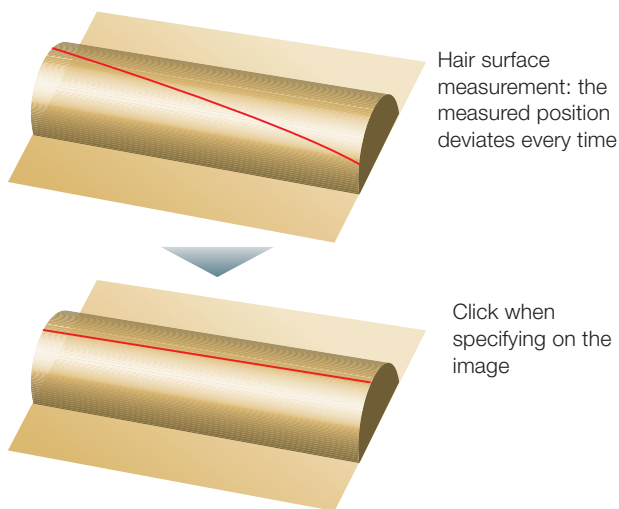

## ISO25178 compliant Area roughness measurement

The OLS5000 microscope scans the sample surface with a 0.4 μm diameter laser beam, enabling it to easily measure the surface roughness of samples that cannot be measured with contact surface roughness gauges. The ability to simultaneously acquire the color image, laser image, and 3D shape data of a surface that can't be measured with a contact surface roughness gauge expands the scope of analysis.

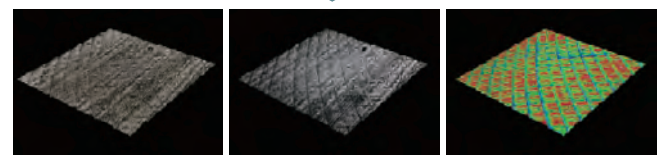
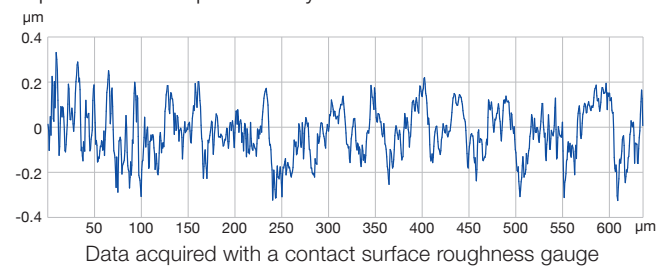

Color image

Laser image

3D shape data

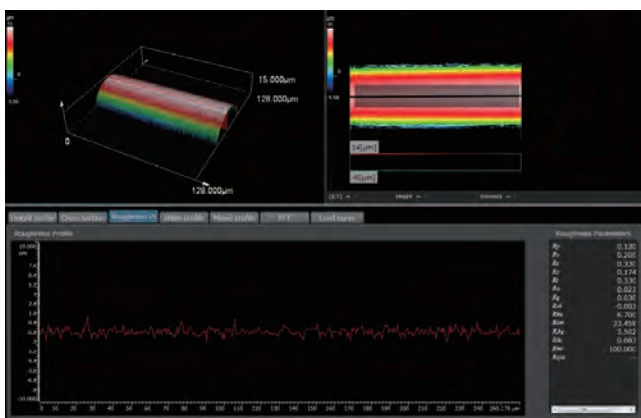

Line roughness measurement of an ultra-thin pipe

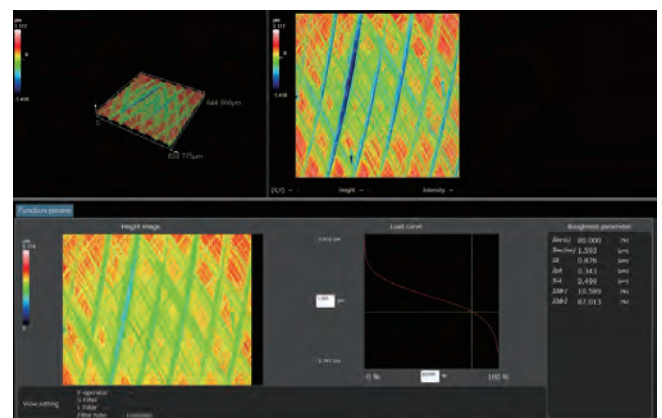

Surface roughness measurement of a polished metallic surface



Since 2011, Olympus has been a member of the Technical Committee of the International Organization for Standardization (ISO/TC213), which was set up to promote the standardization of 3D surface measurement, as well as to promote the use of 3D surface measurement in industry. As part of its ongoing efforts to contribute to the advancement of manufacturing in Japan, Olympus will continue to offer 3D surface measurement solutions compliant with international standards.

## Precise position specification In-plane measurement

Various measurements — including the distance between two points, the angle formed by two lines, and the area of a specified site — can be executed on an image. An auto edge detection function is also provided, enabling precise position specification regardless of the operator's skill.

## Easily compare with the reference plane Step height measurement

Specifying the height reference site and the measurement site, which will be used as a comparison target, in the acquired data, enables you to quantify the maximum, minimum, and average step differences between the reference and measured sites. The specified sites can be saved and loaded later, making this function suitable for repeated measurements.



### Checking the differences between two data items Difference measurement **NEW**

Differences, including go/no-go judgments, shape (height) difference before/after wear, surface areas, and volumes, can be confirmed visually and quantified. Positioning alignment between data (XYZθ) and angle adjustment data in the horizontal direction can be accomplished automatically with a single click, facilitating efficient analysis of differences in surface shape.

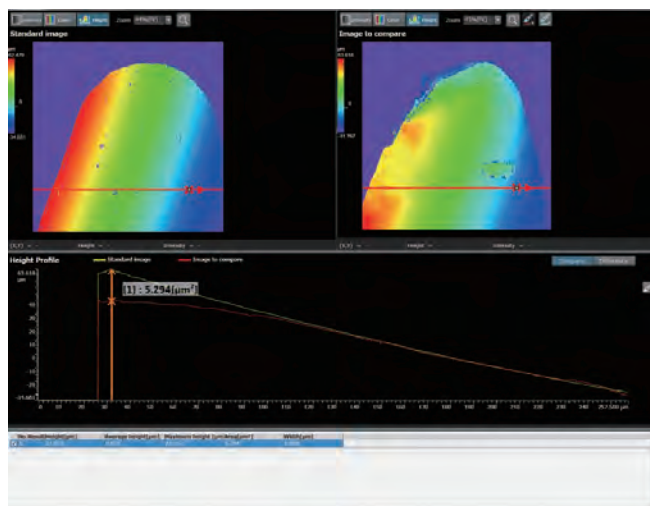

Wear measurement of tool tip (MPLAPON50XLEXT)

### Automatically detect multiple surface irregularities Area/volume measurement

The area and volume of sites with surface irregularities can be measured by setting the reference height plane in the acquired image. The reference plane can also be automatically detected based on the sample's shape. When multiple sites with surface irregularities are detected, the volume, area, surface area and the height from the reference plane of each of site can be measured.

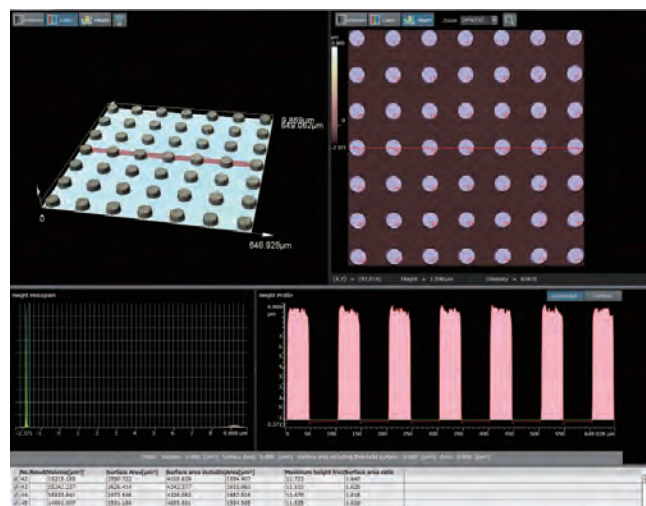

Bump (MPLAPON20XLEXT)

### Auto peak detection capabilities Histogram analysis

The histogram represents the acquired height data or the distribution of color or laser intensity and can be used for step and area measurements. The output of statistical quantities, such as the mode, half-value width, and 3σ, as well as auto histogram peak detection, are also available.

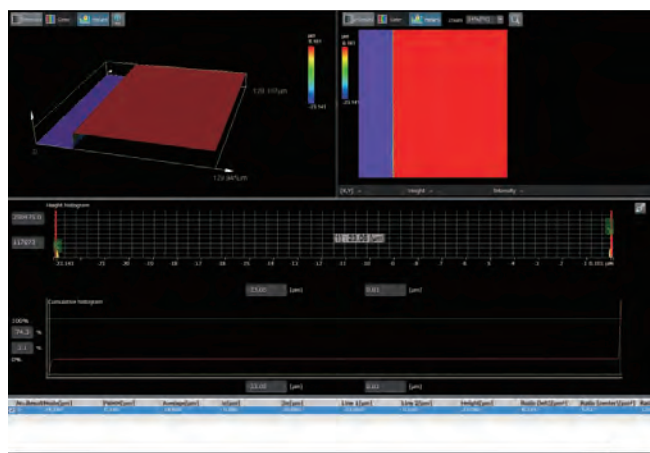

Photoresist (MPLAPON100XLEXT)

### Automatically measure the sphere radius and surface angle

### Sphere/cylinder/surface angle analysis (Available in 2018) **NEW**

When a sample has a repetitive shape — like a microlens array — its radius, residual error, and surface angle can be measured. By specifying a feature section as the site of interest, all identical feature parts in the acquired data can be automatically extracted to output the measurement results.

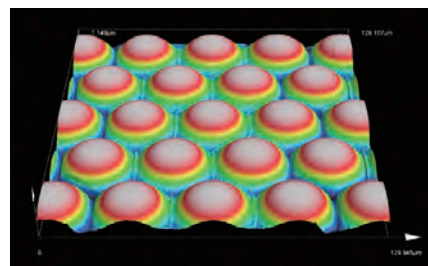

Micro lens array (MPLAPON100XLEXT), courtesy of KOSHIBU PRECISION CO.,LTD.

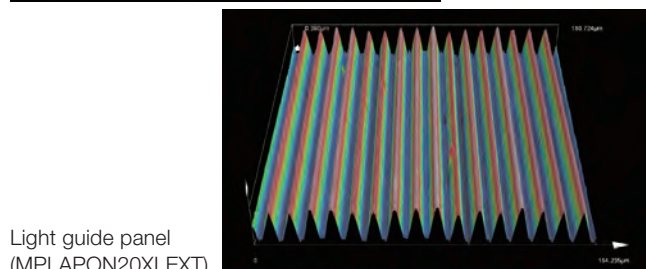

Light guide panel (MPLAPON20XLEXT)

# Comprehensive Analysis and Reporting Functions

## Automatic width/height measurements Auto edge measurement

(Available in 2018) **NEW**

The width and height of a regular pattern on a semiconductor chip can be measured according to specified detection conditions. Various settings can be applied to the color image, laser image, and 3D shape data according to the features of the sample. This function is useful for repeated sample measurements.

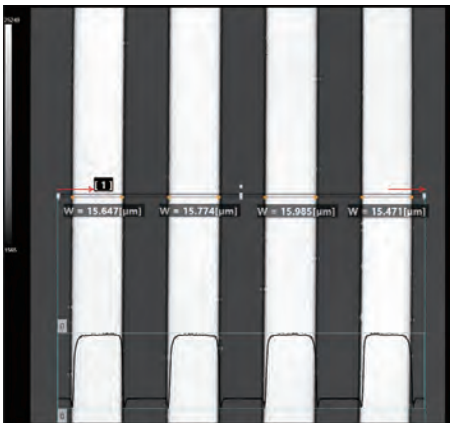

Resist pattern on silicon substrate (MPLAPON100XLEXT)  
Courtesy of Nanotechnology Hub in Kyoto University

## Measuring the thickness of a transparent body Film thickness measurement

(Available in 2018)

The film thickness and interface height of a transparent body can be measured. The multi-layer mode is useful to analyze the 3D extension, structure, and position relationship of a transparent film. The fault mode turns the light detection intensity into an image and is useful when analyzing interfaces with very low reflection intensity.

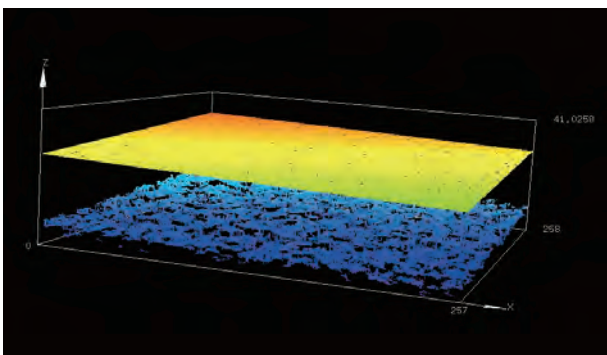

Multi-layer mode



Fault mode

## Automatic particle diameter/center of gravity measurements

### Particle analysis (Available in 2018)

Particles can be detected automatically in the acquired data. The diameter, the center of gravity, Feret's diameter, and the degree of roundness of each particle can be measured. The results can be output in a histogram.

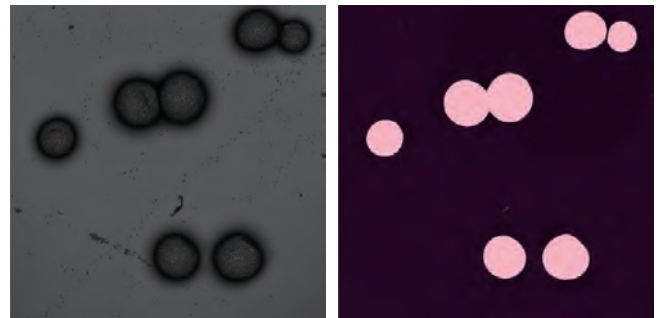

Ceramic particle (MPLAPON20XLEXT)

## Comparative analysis of multiple data items Multi-file analysis

(Available in 2018) **NEW**

Multiple acquired data items can be displayed side by side with their display scales and 3D display angle integrated. Image correction and analysis can be performed simultaneously. This function is useful for analyzing the shape of multiple samples with different processing conditions or for defect analysis.

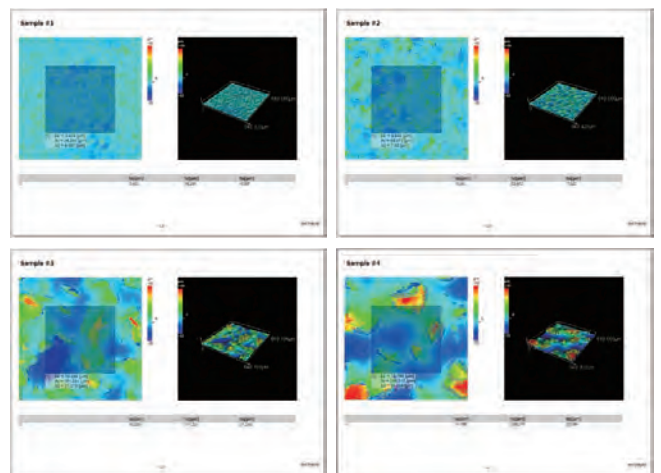

Tool for more specialized analysis  
**OLYMPUS Stream software**

OLYMPUS Stream industrial image analysis software (optional) is used in highly specialized applications. Data captured with the OLS5000 microscope can easily be displayed and analyzed using OLYMPUS Stream software.

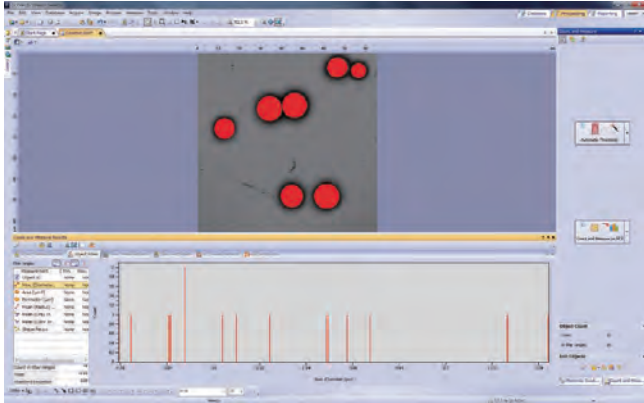

Free layout capability  
**Report output**

Analysis results can be output to a report, which can be customized to whichever output format the user prefers. In addition to the editable LEXT-exclusive format, data can also be exported to Excel®, PDF or RTF.

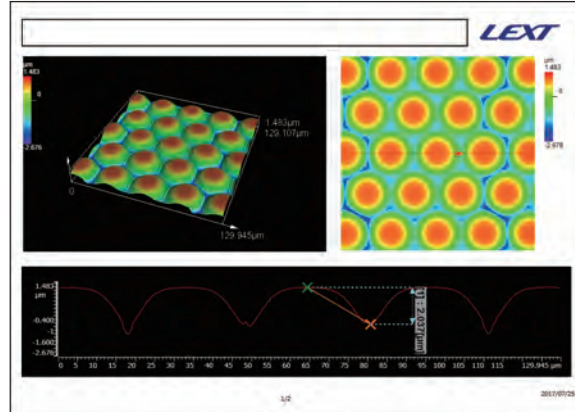

Easy redo/undo  
**Image processing history** **NEW**

The image processing history of the acquired data can be displayed, enabling multiple undo and redo operations. This is convenient when confirming the image processing used for other data or when confirming the processing content with other acquired data.

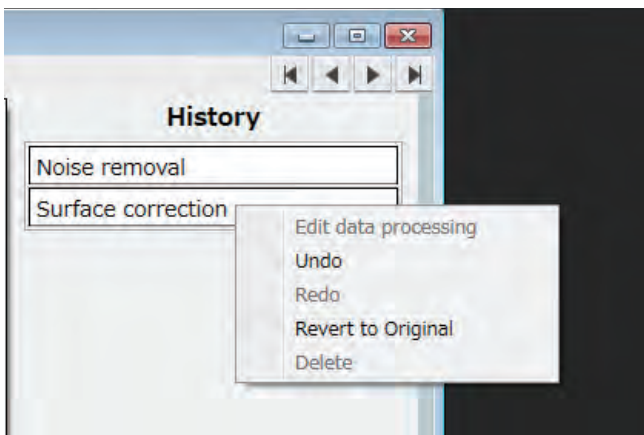

Comparison/analysis with design data  
**CAD data output** **NEW**

Acquired data can be output in the STL format (mesh data) and loaded into a CAD application. The use of commercially available CAD inspection software facilitates visualization and quantification of the differences between the design data and STL data.

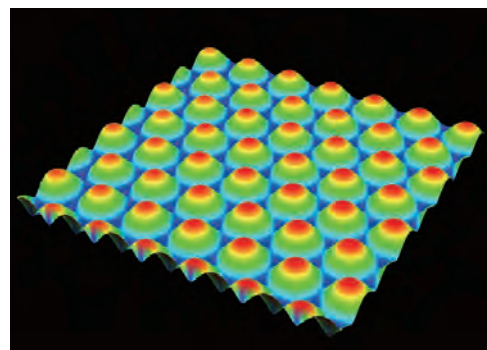

Acquired data (height data)



STL format data

# Automation Functions

## Automating analysis tasks

### Analysis template function **NEW**

All of the operations and procedures included in a report can be saved as a template.

Using this template when repeating the same measurements makes it possible to obtain an analysis report on the next set of data that applies the same procedures. The ability to specify processing operations and measuring points without the operator's intervention enables fast, precise analysis with minimal variance.

Conduct the inspection and take measurements

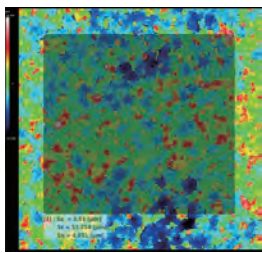

Output the report and save the template

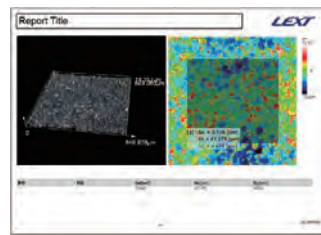

During the next acquisition, open the saved template



Instantly output a report based on the template

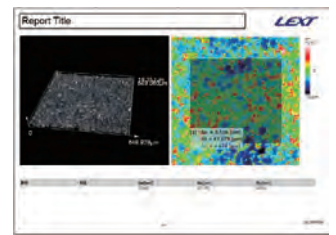

## Position correction with respect to the reference sample

### Auto positioning alignment

Automatic  $XYZ\theta$  adjustments of acquired data are possible by pre-registering the reference sample's feature site. This is useful when repeatedly inspecting the same sample using the Analysis Template function.

## Convenient for repetitive testing

### Alignment function

When testing a succession of samples with similar shapes, the alignment function sets the motorized stage's coordinate system to match the sample's for more efficient inspection. This function enables you can acquire the same data in the same position for all subsequent samples simply by placing the sample on the stage.

## Simultaneous data acquisition from multiple positions

### Multi-area data acquisition

A routine inspection flow, from data acquisition to measurement and reporting, can be automated by creating and editing a macro using the macro compilation tool. Subsequently, all the operator needs to do is to recall and execute an existing macro file to obtain stable measurement results with a single click.

## Fully automated inspection flow

### Macro function **NEW**

The inspection workflow, from data acquisition and measurement to report creation, can be automated. Inspection procedures can be easily created or edited using the macro production tool. Operators can run the registered macro file and obtain reliable measurement results with a single click.

## Designed for reliable use around the world

### Applications available in five languages

Applications are supported in five languages — Japanese, English, German, Chinese and Korean. The instruction manuals are available in several languages, so local operators will be able to use the system.

## Recall a user's settings

### User account function

Each operator can log in to an application with their account and use a customized operating environment. The user ID is recorded in the report, as well as in the acquired data, making it easy to identify who created or acquired the data and when. The administrator is also permitted to assign the range of operations and functions available for each operator as desired.

# Compatible with a Variety of Samples

Accommodates samples up to 210 mm in height

## Extension frame **NEW**

A sample with a maximum height of 210 mm can be placed on the stage. The same measurement performance as the standard frame, including repeatability and accuracy, is guaranteed.



Reference height is adjustable by removing the extension blocks.

Supports a range of samples and measurements

## Many compatible objectives **NEW**

A selection of fifteen objectives are available, including several LEXT-dedicated objectives tuned to the 405 nm wavelength, allowing customers to choose the one best suited to their needs and application. Lenses can also be switched over at the customer's location.



Guaranteed measurement performance

## Dedicated LEXT low-power and long working distance objectives **NEW**

Long WD objectives and a 10x objective have recently been added to our line of dedicated LEXT objectives, enhancing the measurement performance. The measurement performance of all of all dedicated LEXT objectives is guaranteed.

Standard roughness sample 528 by Rubert & Co., Ltd. (Pt = 0.3 μm)

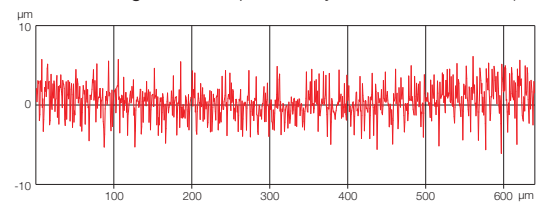

General-purpose lens (50x)

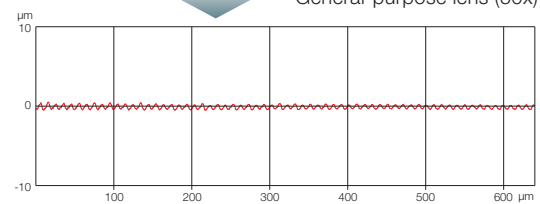

LEXT-dedicated lens (50x)

# LEXT OLS5000 Laser Microscope: Basic Principles

## Configuration

The LEXT OLS5000 3D measuring laser microscope is equipped with two optical systems — color imaging optics and laser confocal optics — that enable it to acquire color information, shape information, and high-definition images.

### [Acquisition of color information]

The color imaging optics acquire color information using a white-light LED light source and CMOS camera.

### [Acquisition of 3D shape information and high-definition confocal images]

The laser confocal optics acquire the confocal image using a 405 nm laser diode light source and a high-sensitivity photomultiplier. The shallow depth of focus enables it to be used to measure a sample's surface irregularities.

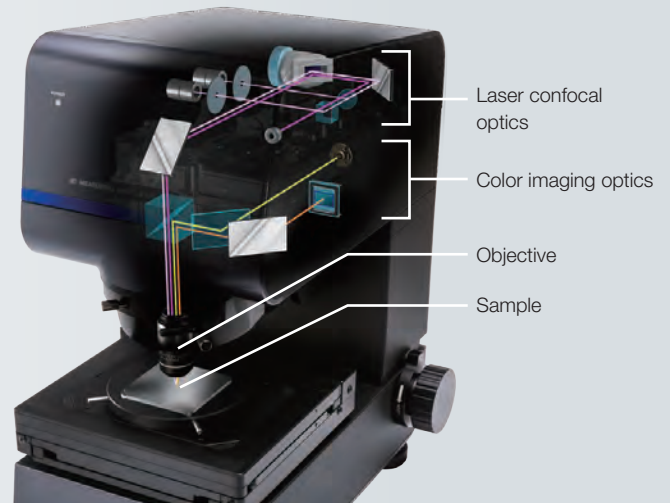

Configuration of the OLS5000 3D Measuring Laser Microscope

## 405 nm Laser Light Source

The lateral resolution of an optical microscope improves as the wavelength decreases. A laser microscope using a short-wavelength laser light has better lateral resolution than a traditional microscope using visible laser light (peak value 550 nm). The OLS5000 microscope employs a 405 nm short-wavelength laser diode to offer an exceptional lateral resolution.

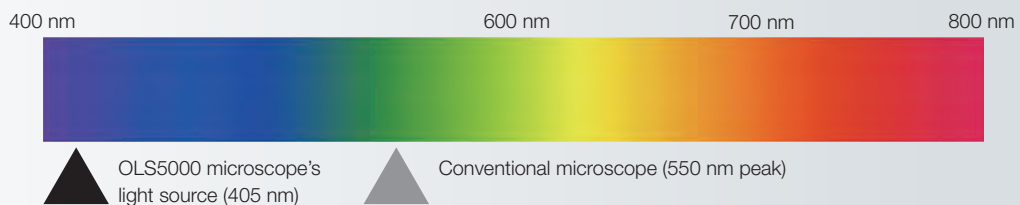

## Laser Confocal Optics

The laser confocal optical system receives only the light focused through the circular pinhole, rather than capturing all the light reflected and scattered from the sample. This helps eliminate blur, making it possible to acquire an image with higher contrast than can be obtained with an ordinary microscope.

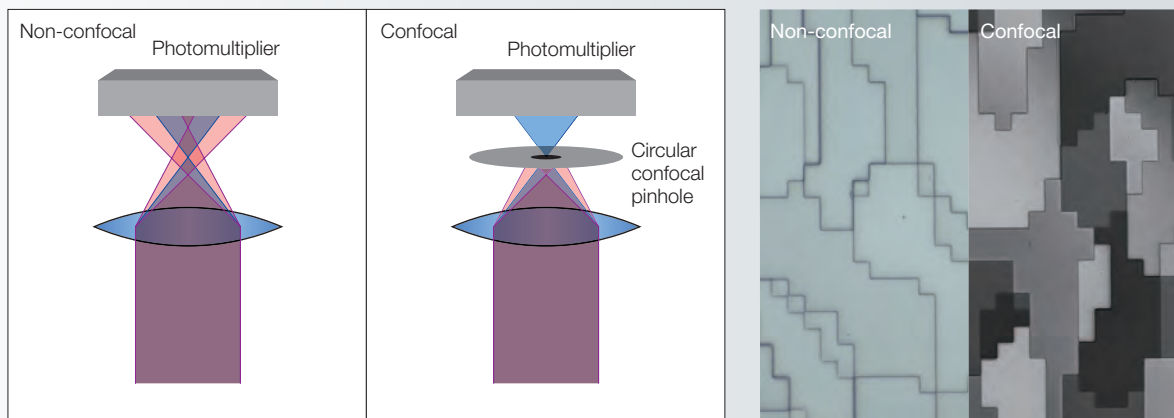

## X-Y Scanner

The OLS5000 microscope incorporates an Olympus optical scanner. The integration of the X-axis, which uses an electromagnetic induction MEMS resonant scanner, and the Y-axis, which uses a Galvano scanner, enables the X-Y scanner to be located in a strictly coupled position with respect to the pupil of the objective. This enables exceptional X-Y scanning with low scan trace distortion and fewer optical aberrations.

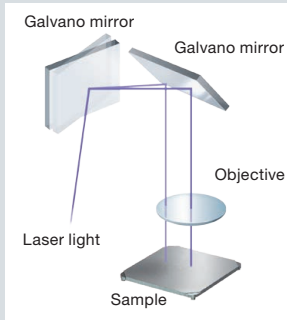

Conventional laser microscope (Proximal Galvano structure)

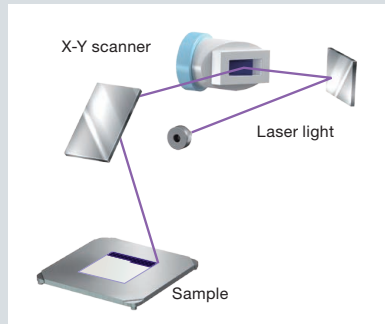

OLS5000 microscope (2-axis integrated structure)



## Principles of Height Measurement

When measuring height, the microscope acquires multiple confocal images by shifting the focus position automatically. Based on the discrete focus position ( $Z$ ) and detected light intensity ( $I$ ), it estimates the light intensity variation curve ( $I$ - $Z$  curve) for each pixel and obtains its peak position and peak intensity. Since the peak positions of all the pixels correspond to the surface irregularities of the sample, it provides 3D shape information for the sample's surface. Similarly, the peak intensity data forms an image where all positions on the sample's surface are brought into focus (extended image).

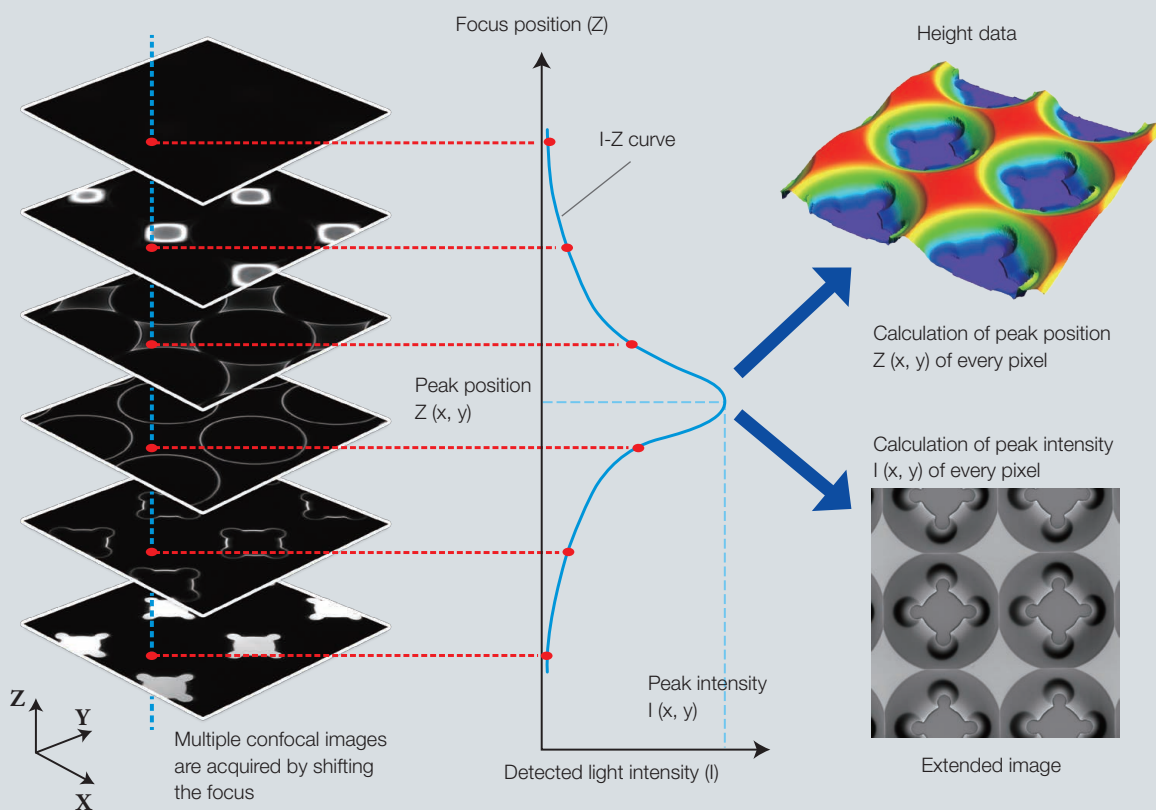

Courtesy of KOSHIBU PRECISION CO.,LTD.

# How the OLS5000 Microscope Compares with Other Measuring Tools

## Optical microscope, digital microscope

**Issue 1** Unable to measure small shapes

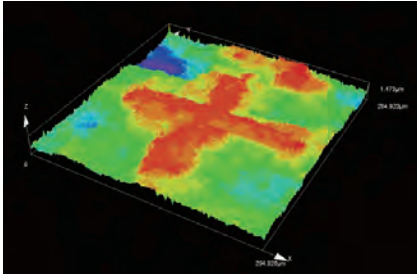

**Precision 3D measurement**

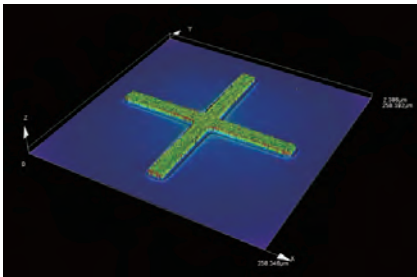

**Issue 2** Poor lateral resolution



**0.12 μm lateral resolution**

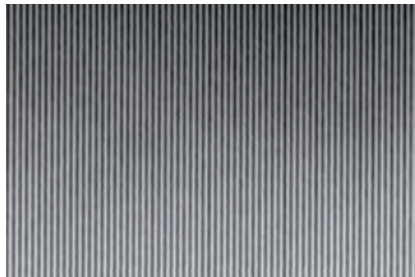

**Issue 3** Non-traceable measurement results

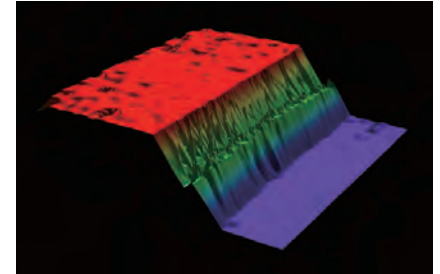

**Traceable measurement results**



## Stylus surface roughness tester

**Issue 1** Can damage the sample's surface

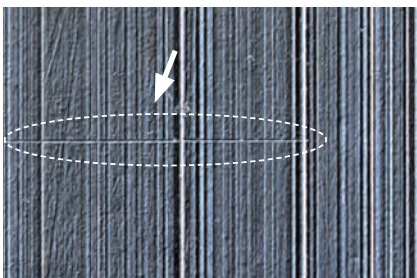

**Non-contact measurement doesn't damage the sample**



**Issue 2** Information from only one line

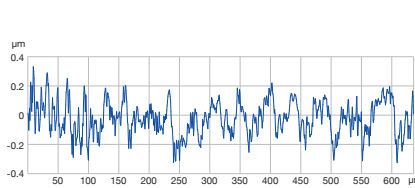

Data with stylus surface roughness meter

**Acquire information from an entire plane**

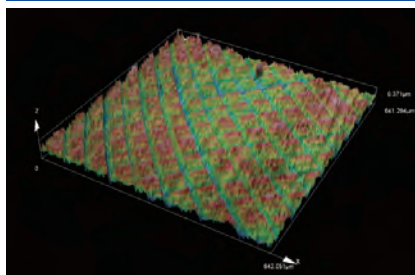

**Issue 3** Difficult to place the stylus on a target position

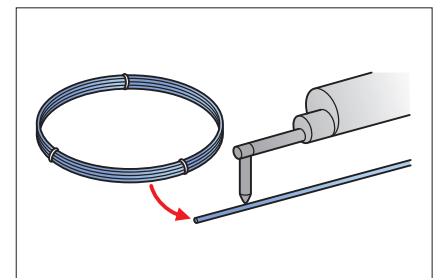

**Pinpoint measurement**

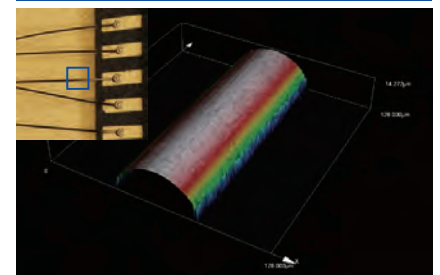



## White light interferometer

**Issue 1** Has difficulty capturing rough surface shapes

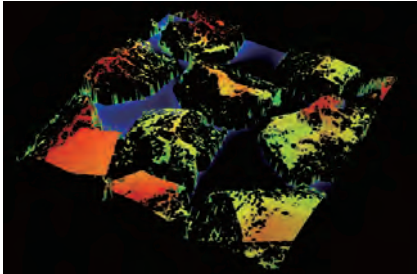

Accurate rough surface measurement by capturing small slopes

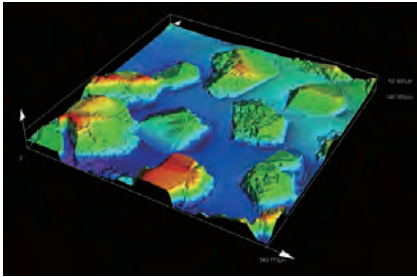

**Issue 2** Poor lateral resolution makes positioning difficult

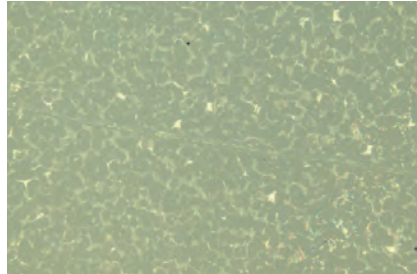

0.12  $\mu\text{m}$  lateral resolution

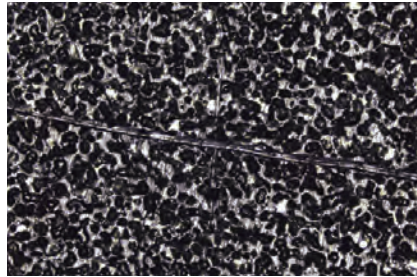

**Issue 3** Inconvenient inclination adjustment

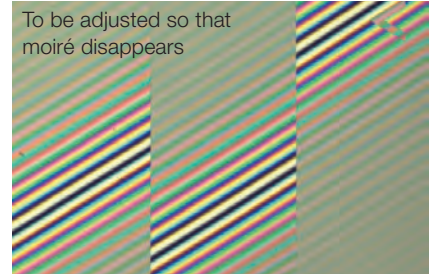

Just place your sample on the stage to start measurement

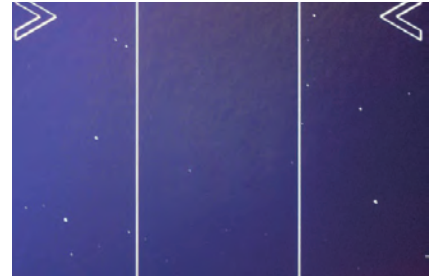

## Scanning electron microscope (SEM)

**Issue 1** No color information

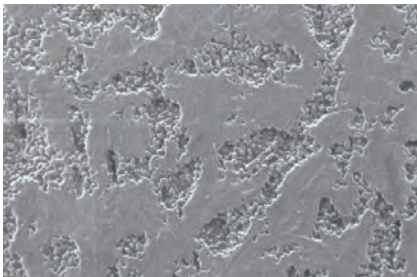

High-definition color observation

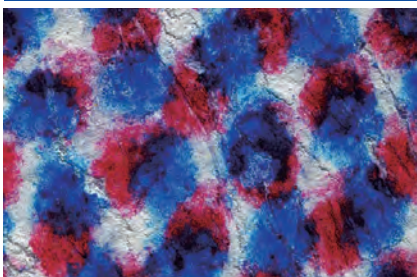

**Issue 2** Samples must be destroyed and prepared in advance

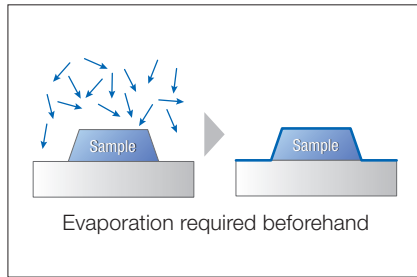

Nondestructive, and no sample preparation required



**Issue 3** 3D shape measurement is not possible

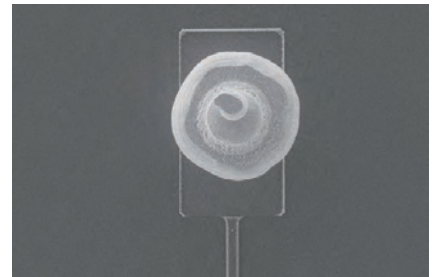

Precise 3D measurement

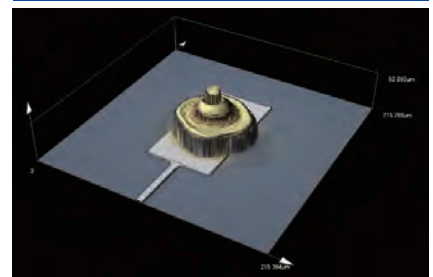

## Automotive/Metal Processing

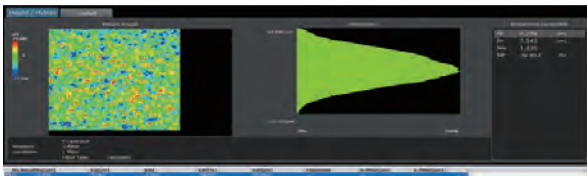
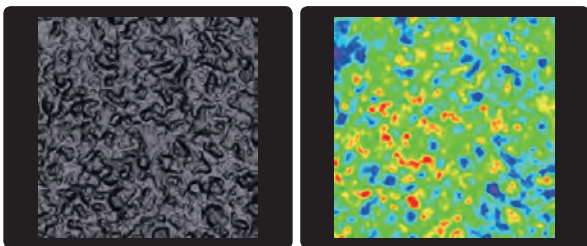
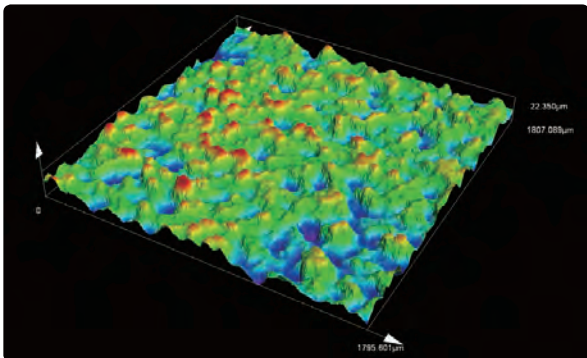

Inner texture / Texture evaluation (Area roughness measurement)  
(MPLAPON20XLEXT / 3x3 stitched)

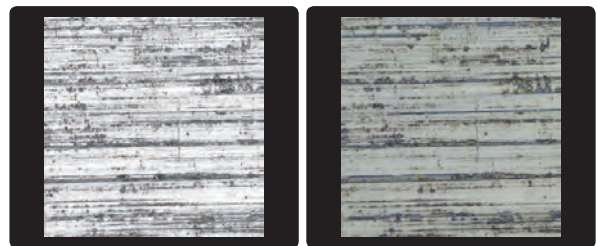
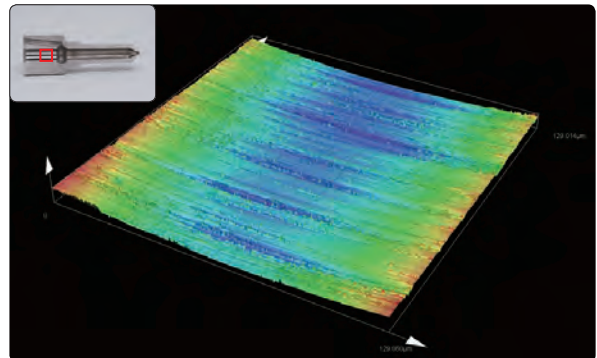

Fuel injector nozzle (replica) / Area roughness measurement  
(LMPLFLN50XLEXT)

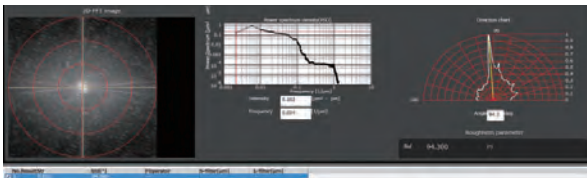
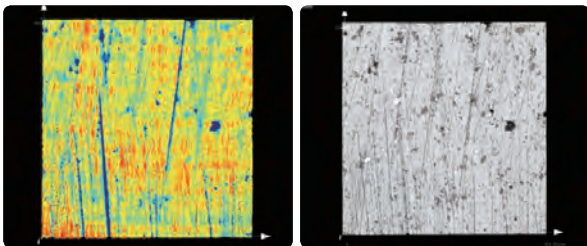
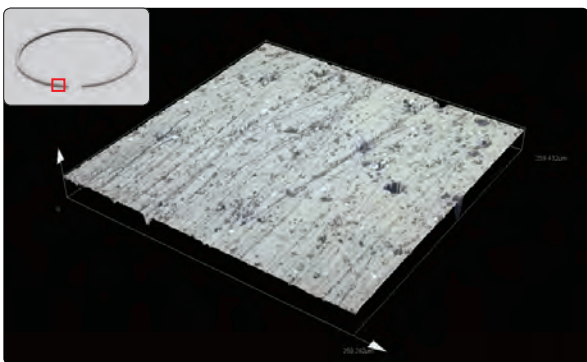

Piston ring / Area roughness measurement  
(MPLAPON50XLEXT)

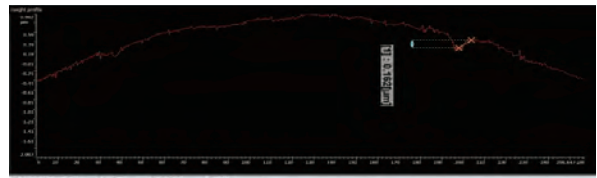
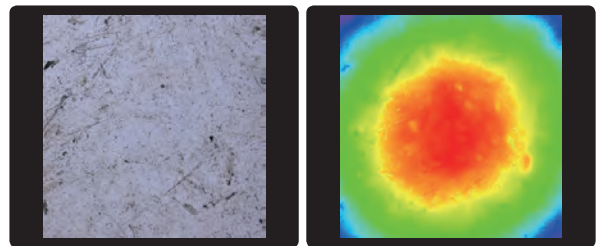
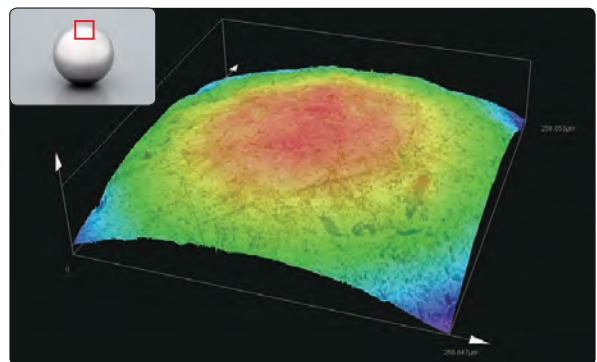

Bearing ball / Scratch depth evaluation (Profile measurement)  
(MPLAPO50XLEXT)

## Materials

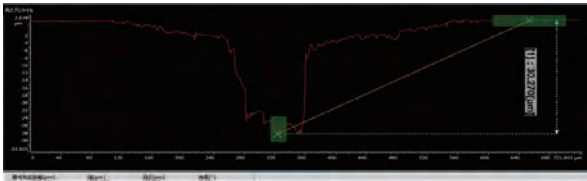
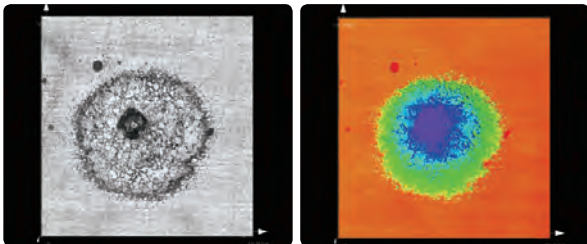
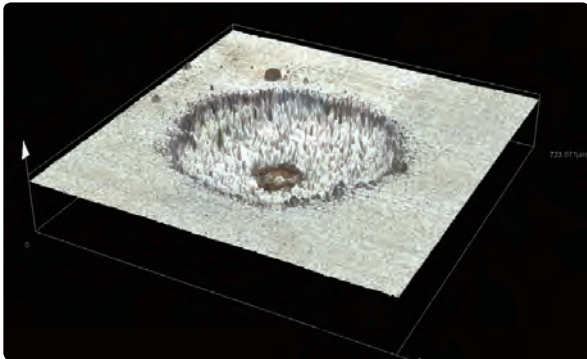

Corrosion on stainless steel / Height measurement  
(MPLAPON20XLEXT / 3x3 stitched)

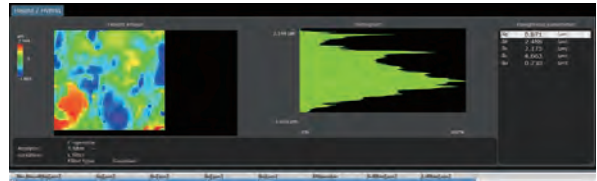
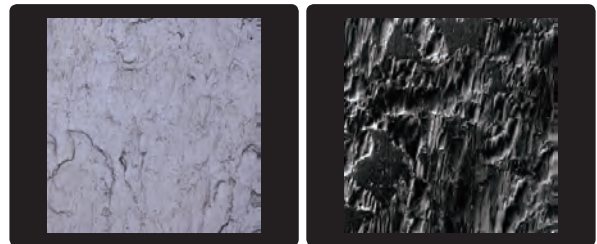
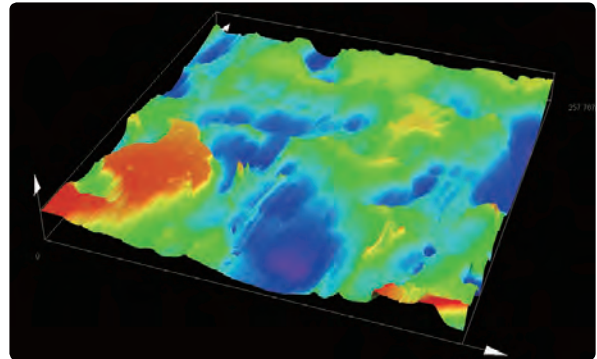

Copper plate / Area roughness measurement  
(MPLAPON50XLEXT)

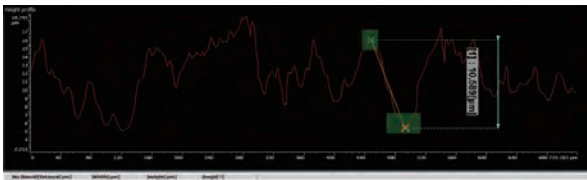
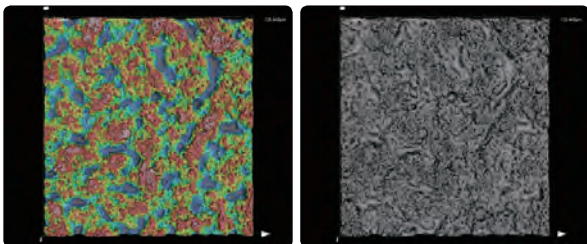
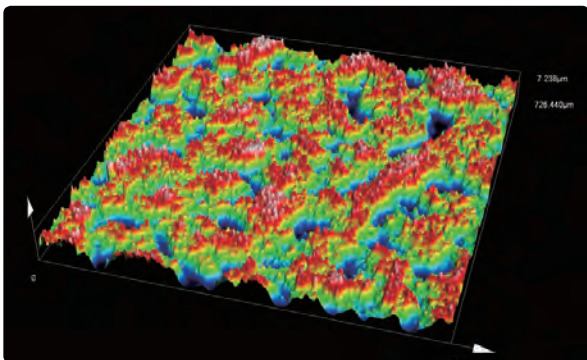

Diffusion plate / Profile measurement  
(MPLAPON50XLEXT / 3x3 stitched)

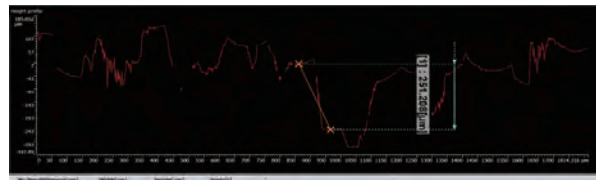
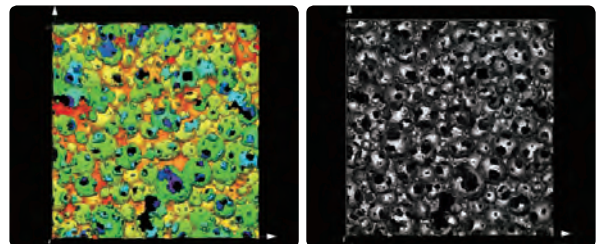
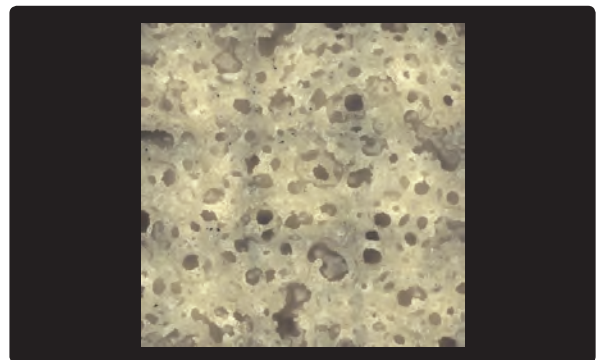

Sponge / Profile measurement  
(MPLAPON20XLEXT / 3x3 stitched)



## Others

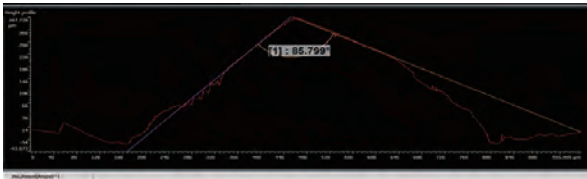
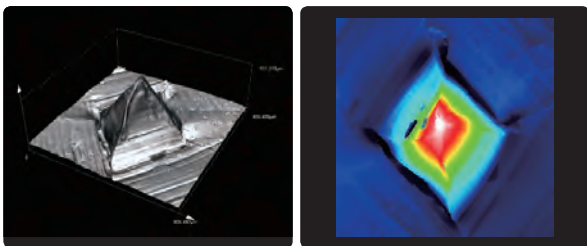
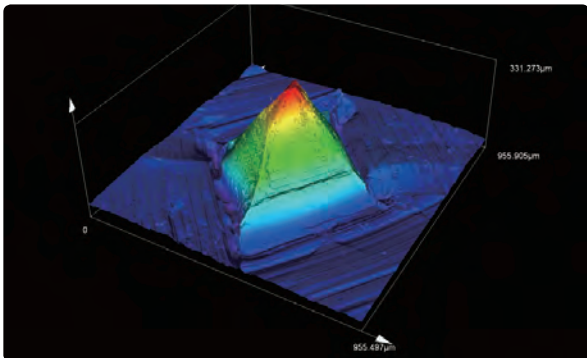

Micro needle / Shape evaluation (Profile measurement)  
(MPLAPON50XLEXT / 6x6 stitched)

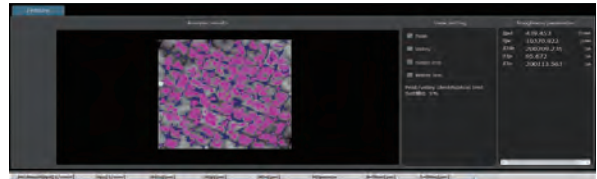
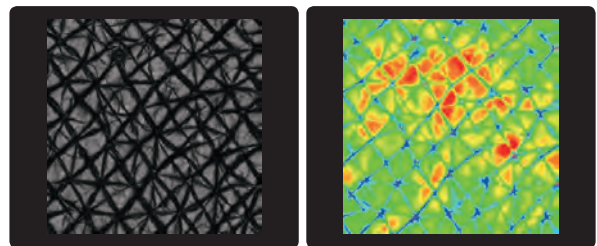
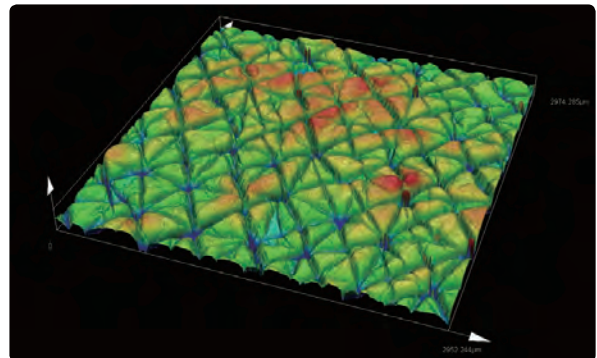

Skin (replica) / Area roughness measurement  
(MPLAPON20XLEXT / 5x5 stitched)

Courtesy of Functional Design Laboratory, Faculty of Fashion Science, Bunka Gakuen University

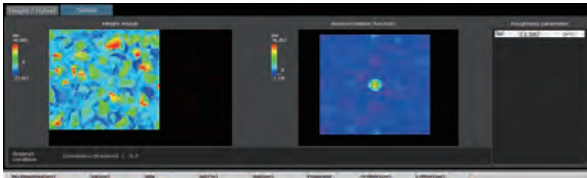
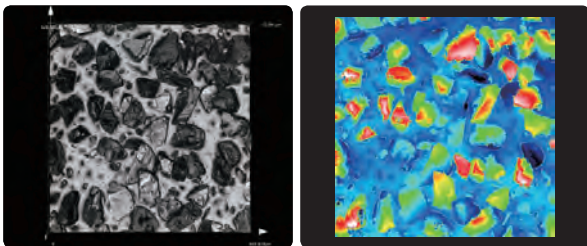
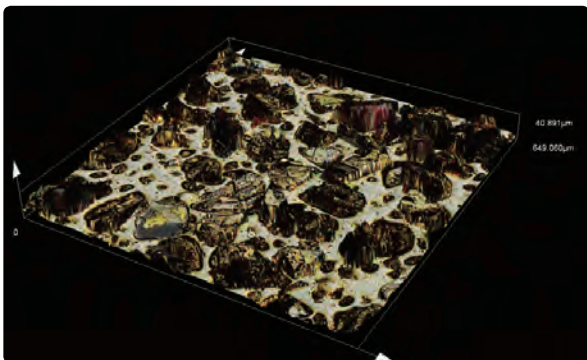

Grind stone / Profile measurement  
(MPLAPON20XLEXT)

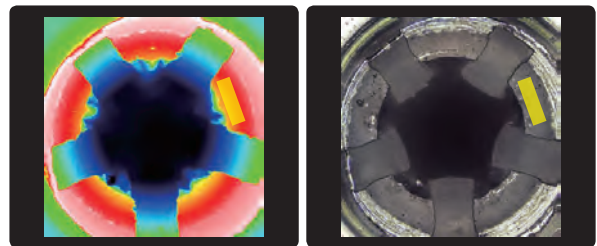
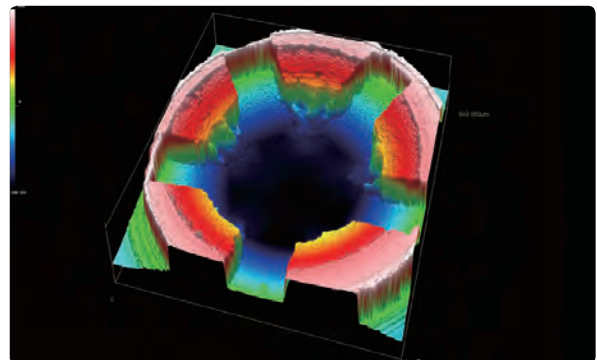

Acceptance seat of ballpoint pen / Area roughness measurement  
(LMPLFLN20XLEXT)

## Product Lineup



OLS5000-SAF Setup Example

### 3D Measuring Laser Microscope OLS5000-SAF

- 100 mm motorized stage
- Max. height of sample: 100 mm

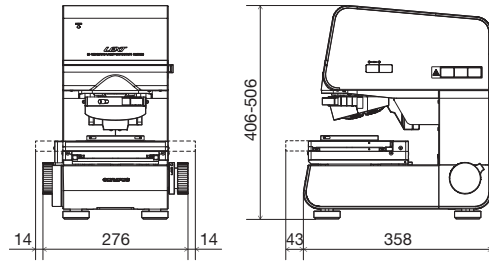

### 3D Measuring Laser Microscope OLS5000-EAF

- 100 mm motorized stage
- Max. height of sample: 210 mm

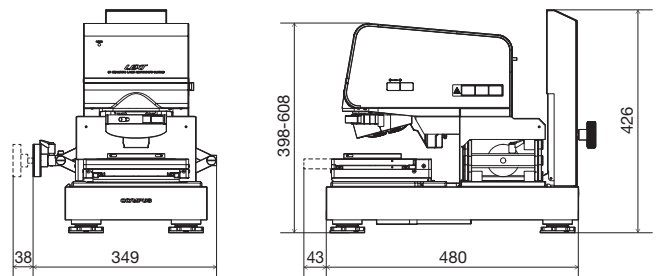

### 3D Measuring Laser Microscope OLS5000-SMF

- 100 mm manual stage
- Max. height of sample: 40 mm

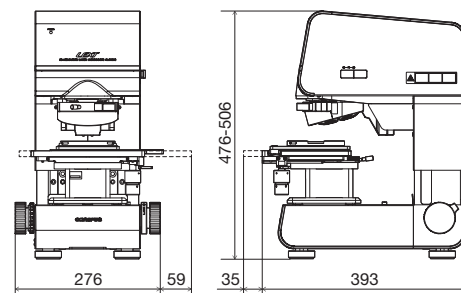

3D Measuring Laser Microscope

# OLS5000-EMF

- 100 mm manual stage
- Max. height of sample: 150 mm

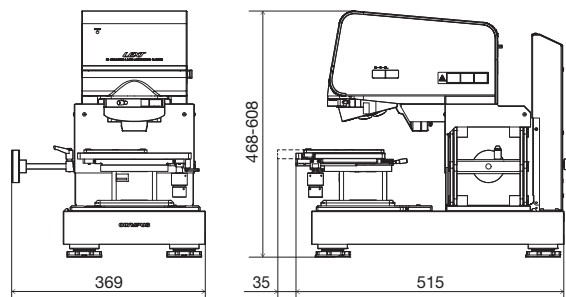

3D Measuring Laser Microscope

# OLS5000-LAF

- 300 mm motorized stage
- Max. height of sample: 37 mm

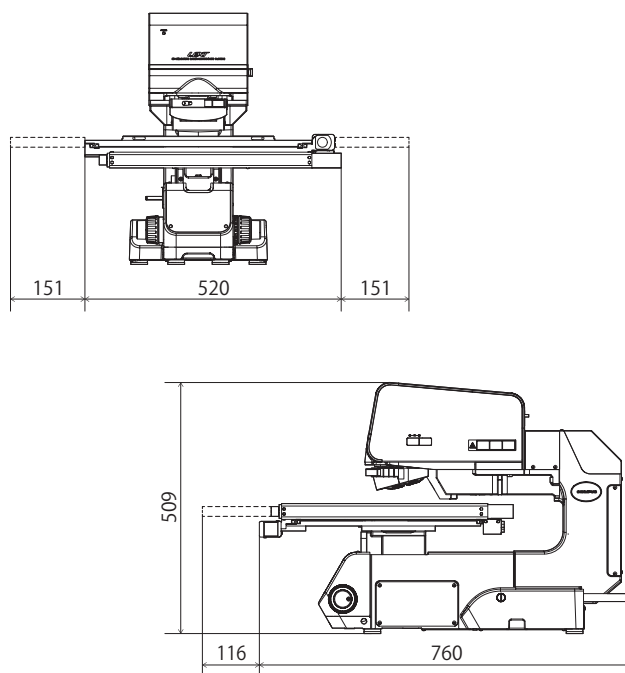

Unit: mm

## PC & Control Unit

Unit: mm

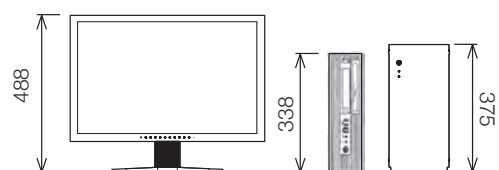
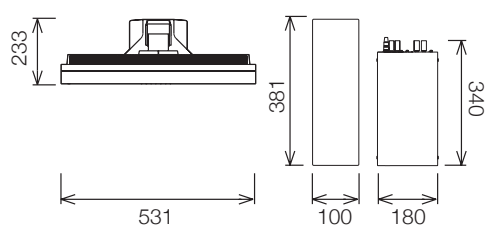

# SPECIFICATIONS

## MAIN UNIT SPECIFICATIONS

Model		OLS5000-SAF	OLS5000-SMF	OLS5000-LAF	OLS5000-EAF	OLS5000-EMF
Total magnification		54x - 17,280x				
Field of view		16 μm - 5,120 μm				
Measurement principle	optical system	Reflection-type confocal laser scanning laser microscope Reflection-type confocal laser scanning laser-DIC microscope Color Color-DIC				
	Light receiving element	Laser: Photomultiplier (2ch) Color: CMOS color camera				
Height measurement	Display resolution	0.5 nm				
	Dynamic range	16 bits				
	Repeatability $\sigma_{n-1}$ *1 *2 *6	20x : 0.03 μm, 50x : 0.012 μm, 100x : 0.012 μm				
	Accuracy *1 *3 *6	Measurement value +/- 1.5%				
	Accuracy for stitched image *1 *4 *6	20x : 15+0.5L μm, 50x : 9+0.5L μm, 100x : 7+0.5L μm (L: Stitching length [μm])				
Width measurement	Measurement noise (Sq noise) *1 *5 *6	1 nm				
	Display resolution	1 nm				
	Repeatability $3\sigma_{n-1}$ *1 *6	20x : 0.05 μm, 50x : 0.04 μm, 100x : 0.02 μm				
	Accuracy *1 *3 *6	Measurement value +/- 1.5%				
Accuracy for stitched image *1 *3 *6		20x : 15+0.5L μm, 50x : 9+0.5L μm, 100x : 7+0.5L μm (L: Stitching length [μm])				
Maximum number of measuring points in a single measurement		4096 x 4096 pix				
Maximum number of measuring points		36 Mpix				
XY stage configuration	Length measurement module	•	NA	NA	•	NA
	Operating range	100 x 100 mm Motorized	100 x 100 mm Manual	300 x 300 mm Motorized	100 x 100 mm Motorized	100 x 100 mm Manual
Maximum sample height		100 mm	30 mm	37 mm	210 mm	140 mm
Laser light source	Wavelength	405 nm				
	Maximum output	0.95 mW				
	Laser class	Class 2 (IEC60825-1:2007, IEC60825-1:2014)				
Color light source		White LED				
Electrical power		240 W	240 W	278 W	240 W	240 W
Mass	Microscope body	Approx. 31 kg	Approx. 32 kg	Approx. 50 kg	Approx. 43 kg	Approx. 44 kg
	Control box	Approx. 12 kg				

\*1 Guaranteed when used in constant temperature and constant-temperature environment (temperature: 20°C±1°C, humidity: 50%±1%) specified in ISO554(1976), JIS Z-8703(1983). \*2 When measured with MPLAPON LEXT series objectives. \*3 When measured with dedicated LEXT objective. \*4 When measured with dedicated LEXT objective of 20X or higher. \*5 Typical value when measured with MPLAPON100XLEXT objective, and may differ from the guaranteed value. \*6 Guaranteed under Olympus Certificate System.

## OBJECTIVE SPECIFICATIONS

Series	Model	Numerical Aperture (NA)	Working Distance (WD)(mm)
UIS2 objective lens	MPLFLN2.5x	0.08	10.7
	MPLFLN5x	0.15	20
LEXT dedicated objective lens (10X)	MPLFLN10xLEXT	0.3	10.4
	MPLAPON20xLEXT	0.6	1
LEXT dedicated objective lens (High performance type)	MPLAPON50xLEXT	0.95	0.35
	MPLAPON100xLEXT	0.95	0.35
	LMPLFLN20xLEXT	0.45	6.5
LEXT dedicated objective lens (Long working distance type)	LMPLFLN50xLEXT	0.6	5
	LMPLFLN100xLEXT	0.8	3.4
	SLMPLN20x	0.25	25
Super long working distance lens	SLMPLN50x	0.35	18
	SLMPLN100x	0.6	7.6
	LCPLFLN20xLCD	0.45	7.4-8.3
Long working distance for LCD lens	LCPLFLN50xLCD	0.7	3.0-2.2
	LCPLFLN100xLCD	0.85	1.0-0.9

## Application Software

Standard Software  
**OLS50-BSW**

Data acquisition app

Analysis app (Simple analysis)

Motorized stage package application\*1 **OLS50-S-MSP**

Extended analysis application\*2 **OLS50-S-AA**

Multi-file analysis application **OLS50-S-MA\***

Film thickness measurement application **OLS50-S-FT\***

Auto edge measurement application **OLS50-S-ED\***

Particle analysis application **OLS50-S-PA\***

Sphere/cylinder surface angle analysis application **OLS50-S-SA\***

\* Available in 2018.

\*1 Including Auto-stitching data acquisition and Multi-area data acquisition functions.

\*2 Including Profile analysis, Difference analysis, Step-height analysis, Surface analysis, Area/volume analysis, Line roughness analysis, Area roughness analysis and Histogram analysis.





## DSX Series Digital Microscopes

The DSX series digital microscopes are also available for evaluation of components consisting various devices as well as for evaluation of samples manufactured by the devices.

Visit Olympus website (<http://www.olympus-ims.com/en/>) for details of the products.

### DSX Digital Microscopes

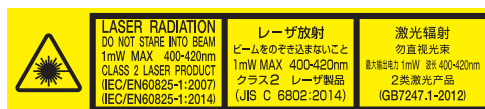

- OLYMPUS CORPORATION is ISO14001 certified.
- OLYMPUS CORPORATION is ISO9001 certified.
- All company and product names are registered trademarks and/or trademarks of their respective owners.
- Performance characteristics and other values described in this brochure are based on Olympus evaluations as of September 2017, and are subject to change without notice.
- The information including guaranteed accuracy in this brochure is based on the condition set by Olympus. For details, refer to the Instruction Manual.
- Images on the PC monitors are simulated.
- Specifications and appearances are subject to change without any notice or obligation on the part of the manufacturer.

[www.olympus-ims.com](http://www.olympus-ims.com)

**OLYMPUS**<sup>®</sup>

OLYMPUS CORPORATION  
Shinjuku Monolith, 2-3-1, Nishi-Shinjuku, Shinjuku-ku, Tokyo 163-0914, Japan